

## DATASHEET

PART NUMBER

**WES1605-1170**

**Wescon 1605 1/4"-28 Threaded Drill Chuck Collet  
- Size 0.117in**

120 degree seating angle. Use standard drill bits with 1/4"-28 threaded angle drill motors

WEBSITE

<https://www.wesconusa.com/products/WES1605-1170>



\* The image represents the general look of the series. Actual product may vary based on options selected.

## SPECIFICATIONS

Mount Type	Male Thread
Chuck Type	Collet Chuck
Thread Size	1/4-28
Size	0.1170in
Country of Origin	USA

**ADDITIONAL IMAGES AND DRAWINGS**



Image 1

**WES1605 Series Drill Chuck Collet**

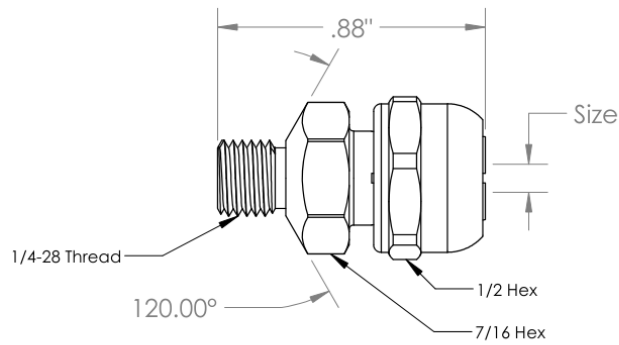

Minimum Size: 0.0700in  
 Maximum Size: 0.2570in

Order as P/N WES1605-(SIZE)  
 See wesconusa.com for full list of available sizes and part numbers.  
 Custom size available upon request.

Used with 1/4-28 threaded angle drill motors

		Part Number	<b>WES1605</b>
		Threaded Drill Chuck Collet	
Revision 03	All dimensions are in Inches	© 2025 Wescon Industries Inc. 601 Century Plaza Dr. Houston, TX 77073, US www.wesconusa.com	Information in this drawing is provided for reference only

Image 2