

DATASHEET

PART NUMBER

WES396-ES-6-SVS-QC

**Wescon 396 Microstop - M6x1 - 12.7 mm Cutter
Capacity - Vacuum Skirt Straight**

SMALL CAPACITY / TIGHT SPACE / EXTENDED STROKE

WEBSITE

<https://www.wesconusa.com/products/WES396-ES-6-SVS-QC>



* The image represents the general look of the series. Actual product may vary based on options selected.

SPECIFICATIONS

Measurement Type	Metric
Bearing Rating	10,000 rpm
Bearing Type	Dual Ball Bearings
Heavy Duty Thrust Bearing	No
Incremental Adjustment	0.0005 in
Shaft Travel	6 mm
Cutter Thread	M6x1
Shaft	Quick Change
Shaft Diameter	1/4 in
Cutter Capacity	12.7 mm
Skirt	Slotted Vacuum Straight
Skirt Description	17.53 mm OD 13.46 mm ID 12.7 mm Cutter Capacity
Solid Stop	Yes
Material	Steel
Vacuum Adapter	Yes
Stroke Length	0.236 in (6mm) Shaft Travel
Country of Origin	USA

ADDITIONAL IMAGES AND DRAWINGS

WES396 Series Microstop



Part Number
WES396-X-XX-XX-XX

- Shaft Option
- Foot Style
- Skirt Option*
- Cutter Thread
- Shaft Travel

Incremental Adjustment: 0.0005 in
 Material: Carbon Steel Body With
 Hardened Tool Steel Shaft

Bearing Rating: 10,000 rpm
 Bearing Type: Dual Ball-Bearings
 Dust Seal: Integrated Dust Seal
 Heavy Duty Thrust Bearing: No
 Solid Stop: Yes

Code	Shaft Travel
(Blank)	0.157in
ES	0.246in

Code	Cutter Thread
(Blank)	1/4-28
6	M6x1

Code	Foot Style
N	Nylon

Code	Shaft Option
(Blank)	1/4in Standard Round
TF	Tri Flat
QC	Quick Change
TS	1/4-28in Threaded Shank

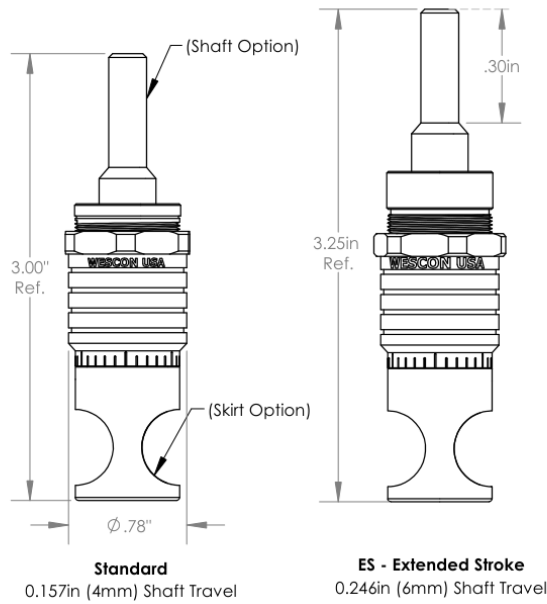

*For Skirt options see next page and website.



Part Number **WES396**

Do not modify, copy, distribute, or reproduce this drawing without prior written authorization.

© 2025 Wescon Industries Inc.
 601 Century Plaza Dr. Houston, TX 77073, US
 www.wesconusa.com

Wescon 396 Microstop

Revision 10 All dimensions are in Inches Information in this drawing is provided for reference only

Image 1

Skirt Option



S
Straight
Cutter $\phi 1/2"$ ($\phi 12\text{mm}$)



I
Internal Thread*
Cutter $\phi 7/16"$ ($\phi 11\text{mm}$)

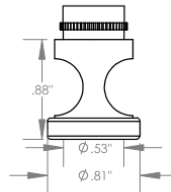

E
External Thread*
Cutter $\phi 1/2"$ ($\phi 12\text{mm}$)



S2L
2-Leg
Cutter $\phi 1/2"$ ($\phi 12\text{mm}$)



SL
Slotted
Cutter $\phi 1/2"$ ($\phi 12\text{mm}$)



SI
Slotted Internal Thread*
Cutter $\phi 7/16"$ ($\phi 11\text{mm}$)

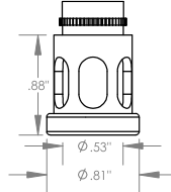

SE
Slotted External Thread*
Cutter $\phi 1/2"$ ($\phi 12\text{mm}$)



S3L
3-Leg
Cutter $\phi 1/2"$ ($\phi 12\text{mm}$)



WVS
Vacuum Straight
Cutter $\phi 1/2"$ ($\phi 12\text{mm}$)

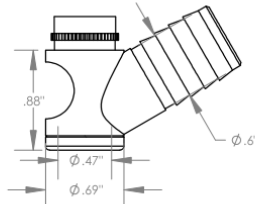

WVI
Vacuum Internal Thread*
Cutter $\phi 7/16"$ ($\phi 11\text{mm}$)

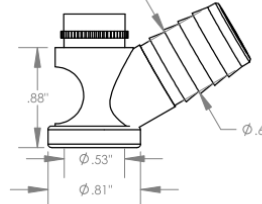

WVE
Vacuum External Thread*
Cutter $\phi 1/2"$ ($\phi 12\text{mm}$)



SCA
Straight Cutaway
Cutter $\phi 1/2"$ ($\phi 12\text{mm}$)



SVS
Slotted Vacuum Straight
Cutter $\phi 1/2"$ ($\phi 12\text{mm}$)

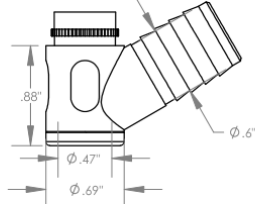

SVI
Slotted Vacuum Internal Thread*
Cutter $\phi 7/16"$ ($\phi 11\text{mm}$)

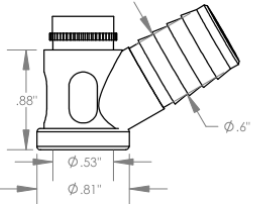

SVE
Slotted Vacuum External Thread*
Cutter $\phi 1/2"$ ($\phi 12\text{mm}$)

*Select foot style from table

Revision 10

Do not modify, copy, distribute, or reproduce this drawing without prior written authorization.

All dimensions are in Inches



© 2025 Wescon Industries Inc.
601 Century Plaza Dr. Houston, TX 77073, US
www.wesconusa.com

Information in this drawing is provided for reference only

Part Number

WES396

Wescon 396 Microstop

Image 2



Part Number	Material
39631-N	Nylon
39631-S	Steel
39631-P	Phenolic

Foot Style For External Thread



Part Number	Material
39620-N	Nylon
39620-S	Steel
39620-P	Phenolic

Foot Style For Internal Thread



Part Number

WES396

Do not modify, copy, distribute, or reproduce this drawing without prior written authorization.

© 2025 Wescon Industries Inc.
601 Century Plaza Dr. Houston, TX 77073, US
www.wesconusa.com

Wescon 396 Microstop

Revision 10

All dimensions are in Inches

Information in this drawing is provided for reference only

Image 3