

DATASHEET

PART NUMBER

WES396-ES-SL-TF

**Wescon 396 Microstop - 1/4-28 - 1/2" Cutter
Capacity - Slotted**

SMALL CAPACITY / TIGHT SPACE / EXTENDED STROKE

WEBSITE

<https://www.wesconusa.com/products/WES396-ES-SL-TF>



* The image represents the general look of the series. Actual product may vary based on options selected.

SPECIFICATIONS

Measurement Type	Imperial
Bearing Rating	10,000 rpm
Bearing Type	Dual Ball Bearings
Heavy Duty Thrust Bearing	No
Incremental Adjustment	0.0005 in
Shaft Travel	0.25 in
Cutter Thread	1/4-28
Shaft	Tri-Flat
Shaft Diameter	1/4 in
Cutter Capacity	1/2 in
Skirt	Slotted
Solid Stop	Yes
Material	Steel
Stroke Length	0.236 in (6mm) Shaft Travel
Country of Origin	USA

ADDITIONAL IMAGES AND DRAWINGS

WES396 Series Microstop



Part Number

WES396-X-XX-XX-XX



Incremental Adjustment: 0.0005 in
 Material: Carbon Steel Body With
 Hardened Tool Steel Shaft

Bearing Rating: 10,000 rpm
 Bearing Type: Dual Ball-Bearings
 Dust Seal: Integrated Dust Seal
 Heavy Duty Thrust Bearing: No
 Solid Stop: Yes

Code	Shaft Travel
(Blank)	0.157in
ES	0.246in

Code	Cutter Thread
(Blank)	1/4-28
6	M6x1

Code	Foot Style
N	Nylon

Code	Shaft Option
(Blank)	1/4in Standard Round
TF	Tri Flat
QC	Quick Change
TS	1/4-28in Threaded Shank

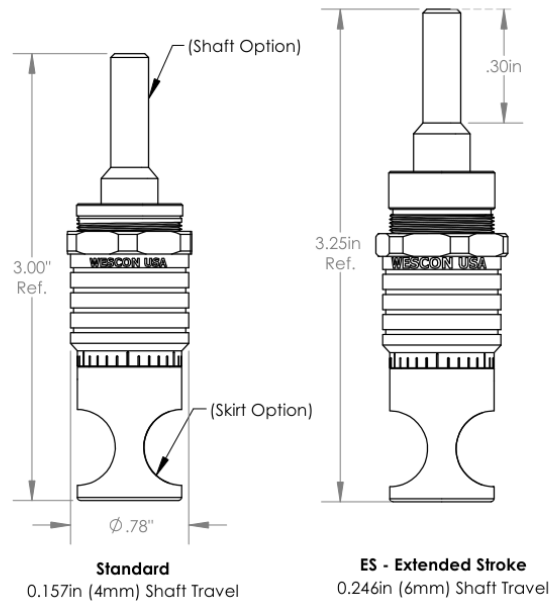

*For Skirt options see next page and website.



Part Number

WES396

Do not modify, copy, distribute, or reproduce this drawing without prior written authorization.

© 2025 Wescon Industries Inc.
 601 Century Plaza Dr. Houston, TX 77073, US
 www.wesconusa.com

Wescon 396 Microstop

Revision 10

All dimensions are in Inches

Information in this drawing is provided for reference only

Image 1

Skirt Option



S
Straight
Cutter Ø 1/2" (Ø 12mm)

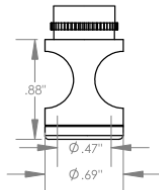

I
Internal Thread*
Cutter Ø 7/16" (Ø 11mm)

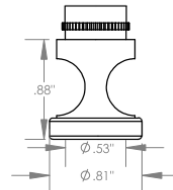

E
External Thread*
Cutter Ø 1/2" (Ø 12mm)

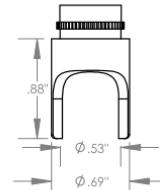

S2L
2-Leg
Cutter Ø 1/2" (Ø 12mm)



SL
Slotted
Cutter Ø 1/2" (Ø 12mm)



SI
Slotted Internal Thread*
Cutter Ø 7/16" (Ø 11mm)



SE
Slotted External Thread*
Cutter Ø 1/2" (Ø 12mm)

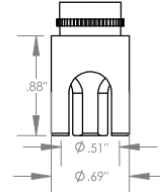

S3L
3-Leg
Cutter Ø 1/2" (Ø 12mm)



WVS
Vacuum Straight
Cutter Ø 1/2" (Ø 12mm)



WVI
Vacuum Internal Thread*
Cutter Ø 7/16" (Ø 11mm)

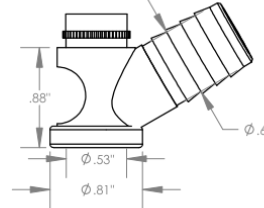

WVE
Vacuum External Thread*
Cutter Ø 1/2" (Ø 12mm)

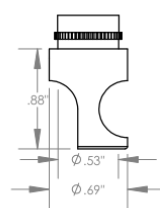

SCA
Straight Cutaway
Cutter Ø 1/2" (Ø 12mm)



SVS
Slotted Vacuum Straight
Cutter Ø 1/2" (Ø 12mm)



SVI
Slotted Vacuum Internal Thread*
Cutter Ø 7/16" (Ø 11mm)

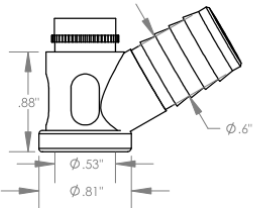

SVE
Slotted Vacuum External Thread*
Cutter Ø 1/2" (Ø 12mm)

*Select foot style from table

Revision 10

Do not modify, copy, distribute, or reproduce this drawing without prior written authorization.

All dimensions are in Inches



© 2025 Wescon Industries Inc.
601 Century Plaza Dr. Houston, TX 77073, US
www.wesconusa.com

Information in this drawing is provided for reference only

Part Number

WES396

Wescon 396 Microstop

Image 2



Part Number	Material
39631-N	Nylon
39631-S	Steel
39631-P	Phenolic

Foot Style For External Thread



Part Number	Material
39620-N	Nylon
39620-S	Steel
39620-P	Phenolic

Foot Style For Internal Thread



Part Number

WES396

Do not modify, copy, distribute, or reproduce this drawing without prior written authorization.

© 2025 Wescon Industries Inc.
601 Century Plaza Dr. Houston, TX 77073, US
www.wesconusa.com

Wescon 396 Microstop

Revision 10

All dimensions are in Inches

Information in this drawing is provided for reference only

Image 3