

## DATASHEET

PART NUMBER

### WES396-S2L-TF

**Wescon 396 Microstop - 1/4-28 - 1/2" Cutter  
Capacity - 2-Leg**

SMALL CAPACITY / TIGHT SPACE APPLICATIONS

WEBSITE

<https://www.wesconusa.com/products/WES396-S2L-TF>



\* The image represents the general look of the series. Actual product may vary based on options selected.

## SPECIFICATIONS

<b>Measurement Type</b>	Imperial
<b>Bearing Rating</b>	10,000 rpm
<b>Bearing Type</b>	Dual Ball Bearings
<b>Heavy Duty Thrust Bearing</b>	No
<b>Incremental Adjustment</b>	0.0005 in
<b>Shaft Travel</b>	0.15 in
<b>Cutter Thread</b>	1/4-28
<b>Shaft</b>	Tri-Flat
<b>Shaft Diameter</b>	1/4 in
<b>Cutter Capacity</b>	1/2 in
<b>Skirt</b>	2-Leg
<b>Solid Stop</b>	Yes
<b>Material</b>	Steel
<b>Stroke Length</b>	0.157 in (4mm) Shaft Travel
<b>Country of Origin</b>	USA

ADDITIONAL IMAGES AND DRAWINGS



Image 0

## WES396 Series Microstop



**Part Number**

WES396-X-XX-XX-XX

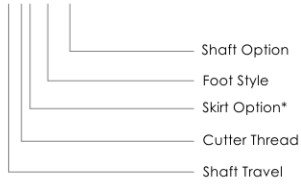

Code	Shaft Travel
(Blank)	0.157in
ES	0.246in

Code	Cutter Thread
(Blank)	1/4-28
6	M6x1

Code	Foot Style
N	Nylon

Code	Shaft Option
(Blank)	1/4in Standard Round
TF	Tri Flat
QC	Quick Change
TS	1/4-28in Threaded Shank

Incremental Adjustment: 0.0005 in  
Material: Carbon Steel Body With Hardened Tool Steel Shaft

Bearing Rating: 10,000 rpm  
Bearing Type: Dual Ball-Bearings  
Dust Seal: Integrated Dust Seal  
Heavy Duty Thrust Bearing: No  
Solid Stop: Yes

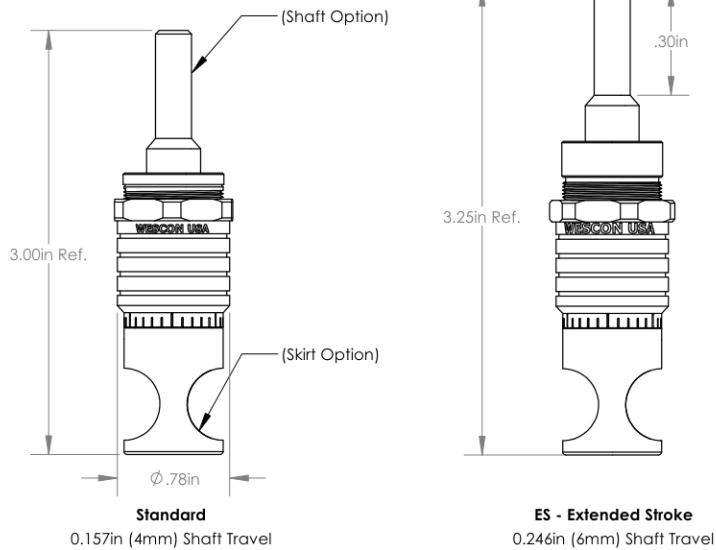

\*For Skirt options see next page and website.



Part Number

**WES396**

Do not modify, copy, distribute, or reproduce this drawing without prior written authorization.

© 2025 Wescon Industries Inc.  
601 Century Plaza Dr. Houston, TX 77073, US  
www.wesconusa.com

Wescon 396 Microstop

Revision 09

All dimensions are in Inches

Information in this drawing is provided for reference only

Image 1

### Skirt Option



**S**  
Straight  
Cutter Ø1/2" (Ø12mm)



**I**  
Internal Thread\*  
Cutter Ø7/16" (Ø11mm)

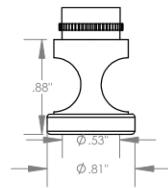

**E**  
External Thread\*  
Cutter Ø1/2" (Ø12mm)

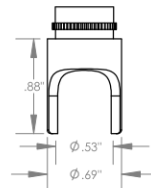

**S2L**  
2-Leg  
Cutter Ø1/2" (Ø12mm)



**SL**  
Slotted  
Cutter Ø1/2" (Ø12mm)



**SI**  
Slotted Internal Thread\*  
Cutter Ø7/16" (Ø11mm)

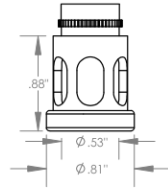

**SE**  
Slotted External Thread\*  
Cutter Ø1/2" (Ø12mm)

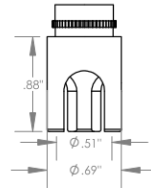

**S3L**  
3-Leg  
Cutter Ø1/2" (Ø12mm)

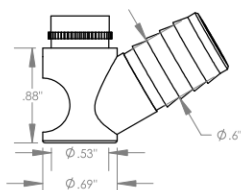

**WVS**  
Vacuum Straight  
Cutter Ø1/2" (Ø12mm)

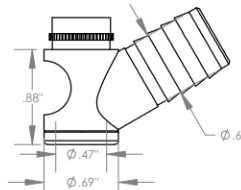

**WVI**  
Vacuum Internal Thread\*  
Cutter Ø7/16" (Ø11mm)

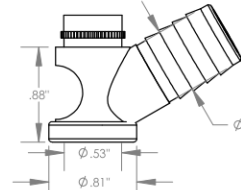

**WVE**  
Vacuum External Thread\*  
Cutter Ø1/2" (Ø12mm)

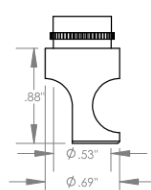

**SCA**  
Straight Cutaway  
Cutter Ø1/2" (Ø12mm)

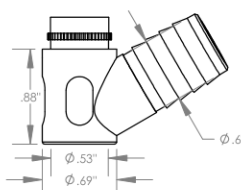

**SVS**  
Slotted Vacuum Straight  
Cutter Ø1/2" (Ø12mm)

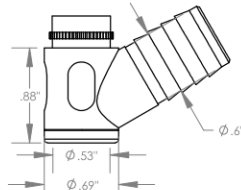

**SVI**  
Slotted Vacuum Internal Thread\*  
Cutter Ø7/16" (Ø11mm)

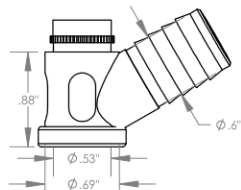

**SVE**  
Slotted Vacuum External Thread\*  
Cutter Ø1/2" (Ø12mm)

\*Select foot style from table

Revision 09

Do not modify, copy, distribute, or reproduce this drawing without prior written authorization.

All dimensions are in inches



© 2025 Wescon Industries Inc.  
601 Century Plaza Dr. Houston, TX 77073, US  
www.wesconusa.com

Information in this drawing is provided for reference only

Part Number

**WES396**

Wescon 396 Microstop

Image 2

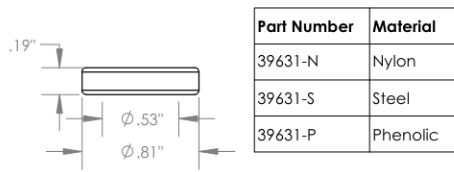

Part Number	Material
39631-N	Nylon
39631-S	Steel
39631-P	Phenolic

Foot Style For External Thread

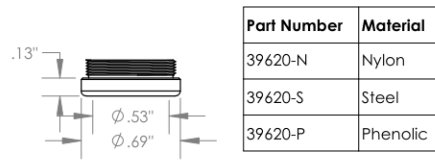

Part Number	Material
39620-N	Nylon
39620-S	Steel
39620-P	Phenolic

Foot Style For Internal Thread



Part Number

**WES396**

Do not modify, copy, distribute, or reproduce this drawing without prior written authorization.

© 2025 Wescon Industries Inc.  
601 Century Plaza Dr. Houston, TX 77073, US  
www.wesconusa.com

Wescon 396 Microstop

Revision 09

All dimensions are in inches

Information in this drawing is provided for reference only

Image 3