

DATASHEET

PART NUMBER

WES397-6-IN-TF

**Wescon 397 Stainless Steel Microstop - M6x1 -
11 mm Cutter Capacity - Internal Thread Skirt -
Nylon Foot**

SMALL CAPACITY / TIGHT SPACE APPLICATIONS
STAINLESS STEEL

WEBSITE

<https://www.wesconusa.com/products/WES397-6-IN-TF>



* The image represents the general look of the series. Actual product may vary based on options selected.

SPECIFICATIONS

Measurement Type	Metric
Bearing Rating	10,000 rpm
Bearing Type	Dual Ball Bearings
Heavy Duty Thrust Bearing	No
Incremental Adjustment	0.0005 in
Shaft Travel	4 mm
Cutter Thread	M6x1
Shaft	Tri-Flat
Shaft Diameter	1/4 in
Cutter Capacity	11 mm
Skirt	Internal Thread
Skirt Description	11 mm Cutter Capacity
Foot	Nylon
Solid Stop	Yes
Material	Stainless Steel
Stroke Length	0.157 in (4mm) Shaft Travel
Country of Origin	USA

ADDITIONAL IMAGES AND DRAWINGS



Image 0

WES397 Series Microstop



Part Number
WES397-X-XX-XX-XX

- Shaft Option
- Foot Style
- Skirt Option*
- Cutter Thread
- Shaft Travel

Code	Shaft Travel
(Blank)	0.157in
ES	0.246in

Code	Cutter Thread
(Blank)	1/4-28
6	M6x1

Code	Foot Style
N	Nylon

Code	Shaft Option
(Blank)	1/4in Standard Round
TF	Tri Flat
QC	Quick Change
TS	1/4-28in Threaded Shank

Incremental Adjustment: 0.0005 in
Material: Stainless Steel

Bearing Rating: 10,000 rpm
Bearing Type: Dual Ball-Bearings
Dust Seal: Integrated Dust Seal
Heavy Duty Thrust Bearing: No
Solid Stop: Yes



*For Skirt options see next page and website.



Part Number

WES397

Do not modify, copy, distribute, or reproduce this drawing without prior written authorization.

© 2025 Wescon Industries Inc.
601 Century Plaza Dr. Houston, TX 77073, US
www.wesconusa.com

Wescon 397 Microstop

Revision 04

All dimensions are in Inches

Information in this drawing is provided for reference only

Image 1

Skirt Option

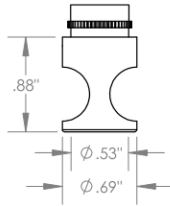

S
Straight
Cutter $\phi 1/2''$ ($\phi 12\text{mm}$)

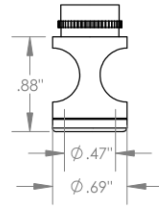

I
Internal Thread
Cutter $\phi 7/16''$ ($\phi 11\text{mm}$)
Choose Foot Style From Table

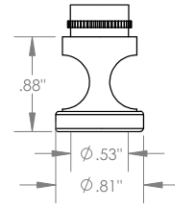

E
External Thread
Cutter $\phi 1/2''$ ($\phi 12\text{mm}$)
Choose Foot Style From Table

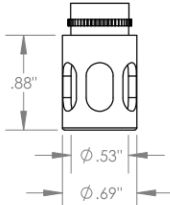

SL
Slotted
Cutter $\phi 1/2''$ ($\phi 12\text{mm}$)

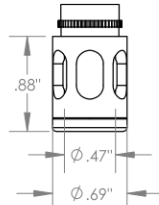

SI
Slotted Internal Thread
Cutter $\phi 7/16''$ ($\phi 11\text{mm}$)
Choose Foot Style From Table

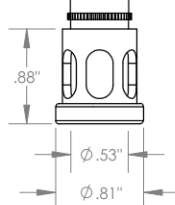

SE
Slotted External Thread
Cutter $\phi 1/2''$ ($\phi 12\text{mm}$)
Choose Foot Style From Table

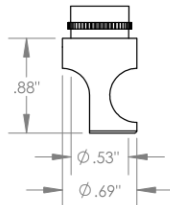

SCA
Straight Cutaway
Cutter $\phi 1/2''$ ($\phi 12\text{mm}$)

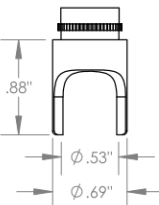

S2L
2-Leg
Cutter $\phi 1/2''$ ($\phi 12\text{mm}$)

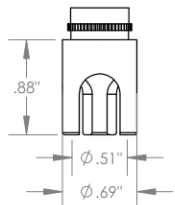

S3L
3-Leg
Cutter $\phi 1/2''$ ($\phi 12\text{mm}$)

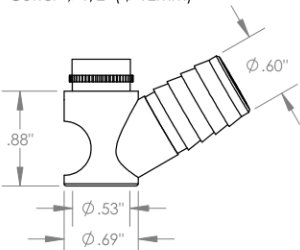

WVS
Vacuum Straight
Cutter $\phi 1/2''$ ($\phi 12\text{mm}$)

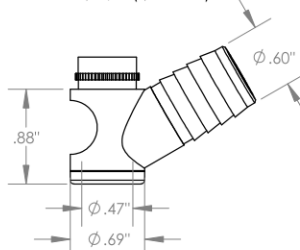

WVI
Vacuum Internal Thread
Cutter $\phi 7/16''$ ($\phi 11\text{mm}$)
Choose Foot Style From Table

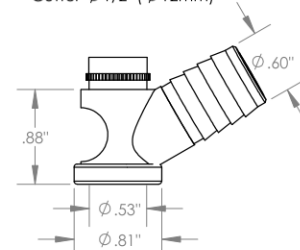

WVE
Vacuum External Thread
Cutter $\phi 1/2''$ ($\phi 12\text{mm}$)
Choose Foot Style From Table



Part Number

WES397

Do not modify, copy, distribute, or reproduce this drawing without prior written authorization.

© 2025 Wescon Industries Inc.
601 Century Plaza Dr. Houston, TX 77073, US
www.wesconusa.com

Wescon 397 Microstop

Revision 05

All dimensions are in Inches

Information in this drawing is provided for reference only

Image 2

**Foot Style
For External Thread**



Part Number	Material
39631-N	Nylon
39631-S	Steel
39631-P	Phenolic

**Foot Style
For Internal Thread**



Part Number	Material
39620-N	Nylon
39620-S	Steel
39620-P	Phenolic



Part Number	WES397
-------------	---------------

Do not modify, copy, distribute, or reproduce this drawing without prior written authorization.

© 2025 Wescon Industries Inc.
601 Century Plaza Dr. Houston, TX 77073, US
www.wesconusa.com

Wescon 397 Microstop

Revision 05	All dimensions are in Inches	Information in this drawing is provided for reference only
-------------	------------------------------	--

Image 3