

## DATASHEET

PART NUMBER

# WES397-6-SVIN

**Wescon 397 Stainless Steel Microstop - M6x1 - 11 mm Cutter Capacity - Vacuum Skirt Internal Nylon Foot**

SMALL CAPACITY / TIGHT SPACE APPLICATIONS  
STAINLESS STEEL

WEBSITE

<https://www.wesconusa.com/products/WES397-6-SVIN>



\* The image represents the general look of the series. Actual product may vary based on options selected.

## SPECIFICATIONS

<b>Measurement Type</b>	Metric
<b>Bearing Rating</b>	10,000 rpm
<b>Bearing Type</b>	Dual Ball Bearings
<b>Heavy Duty Thrust Bearing</b>	No
<b>Incremental Adjustment</b>	0.013 mm
<b>Shaft Travel</b>	4 mm
<b>Cutter Thread</b>	M6x1
<b>Shaft</b>	Round
<b>Shaft Diameter</b>	6.35 mm
<b>Cutter Capacity</b>	11 mm
<b>Skirt</b>	Slotted Vacuum Internal Thread
<b>Skirt Description</b>	17.53 mm OD 11.94 mm ID 11 mm Cutter Capacity
<b>Foot</b>	Nylon
<b>Solid Stop</b>	Yes
<b>Material</b>	Stainless Steel
<b>Vacuum Adapter</b>	Yes
<b>Stroke Length</b>	0.157 in (4mm) Shaft Travel

**ADDITIONAL IMAGES AND DRAWINGS**

**WES397 Series Microstop**



**Part Number**  
WES397-X-XX-XX-XX



Incremental Adjustment: 0.0005 in  
Material: Stainless Steel

Bearing Rating: 10,000 rpm  
Bearing Type: Dual Ball-Bearings  
Dust Seal: Integrated Dust Seal  
Heavy Duty Thrust Bearing: No  
Solid Stop: Yes

Code	Shaft Travel
(Blank)	0.157in
ES	0.246in

Code	Cutter Thread
(Blank)	1/4-28
6	M6x1

Code	Foot Style
N	Nylon

Code	Shaft Option
(Blank)	1/4in Standard Round
TF	Tri Flat
QC	Quick Change
TS	1/4-28in Threaded Shank

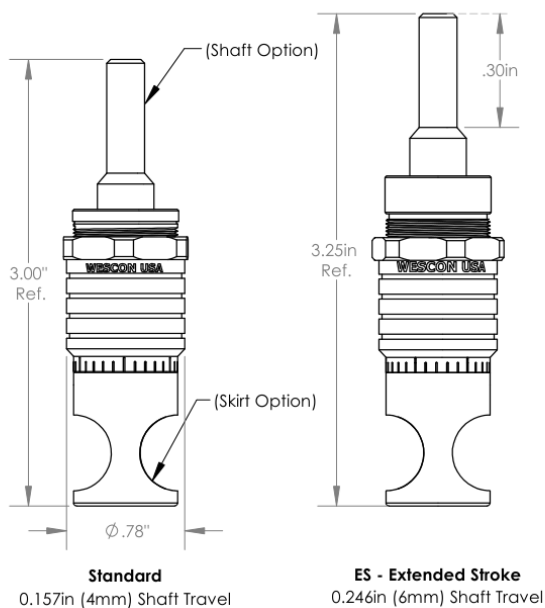

\*For Skirt options see next page and website.



Part Number

**WES397**

Do not modify, copy, distribute, or reproduce this drawing without prior written authorization.

© 2025 Wescon Industries Inc.  
601 Century Plaza Dr. Houston, TX 77073, US  
www.wesconusa.com

Wescon 397 Microstop

Revision 05 All dimensions are in Inches Information in this drawing is provided for reference only

Image 1

### Skirt Option



**S**  
Straight  
Cutter  $\phi 1/2"$  ( $\phi 12\text{mm}$ )

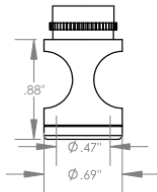

**I**  
Internal Thread\*  
Cutter  $\phi 7/16"$  ( $\phi 11\text{mm}$ )



**E**  
External Thread\*  
Cutter  $\phi 1/2"$  ( $\phi 12\text{mm}$ )

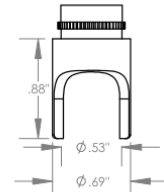

**S2L**  
2-Leg  
Cutter  $\phi 1/2"$  ( $\phi 12\text{mm}$ )



**SL**  
Slotted  
Cutter  $\phi 1/2"$  ( $\phi 12\text{mm}$ )

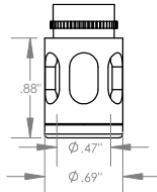

**SI**  
Slotted Internal Thread\*  
Cutter  $\phi 7/16"$  ( $\phi 11\text{mm}$ )



**SE**  
Slotted External Thread\*  
Cutter  $\phi 1/2"$  ( $\phi 12\text{mm}$ )

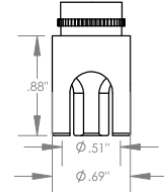

**S3L**  
3-Leg  
Cutter  $\phi 1/2"$  ( $\phi 12\text{mm}$ )



**WVS**  
Vacuum Straight  
Cutter  $\phi 1/2"$  ( $\phi 12\text{mm}$ )

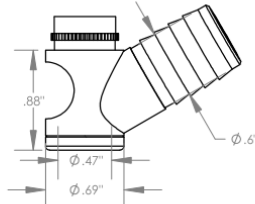

**WVI**  
Vacuum Internal Thread\*  
Cutter  $\phi 7/16"$  ( $\phi 11\text{mm}$ )

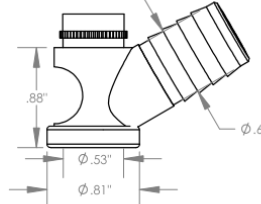

**WVE**  
Vacuum External Thread\*  
Cutter  $\phi 1/2"$  ( $\phi 12\text{mm}$ )

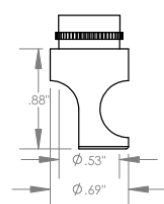

**SCA**  
Straight Cutaway  
Cutter  $\phi 1/2"$  ( $\phi 12\text{mm}$ )



**SVS**  
Slotted Vacuum Straight  
Cutter  $\phi 1/2"$  ( $\phi 12\text{mm}$ )

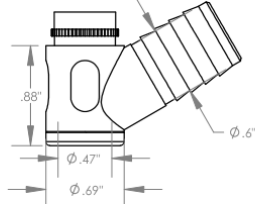

**SVI**  
Slotted Vacuum Internal Thread\*  
Cutter  $\phi 7/16"$  ( $\phi 11\text{mm}$ )

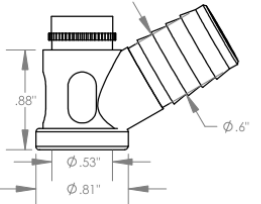

**SVE**  
Slotted Vacuum External Thread\*  
Cutter  $\phi 1/2"$  ( $\phi 12\text{mm}$ )

\*Select foot style from table

Revision 06

Do not modify, copy, distribute, or reproduce this drawing without prior written authorization.

All dimensions are in Inches



© 2025 Wescon Industries Inc.  
601 Century Plaza Dr. Houston, TX 77073, US  
www.wesconusa.com

Information in this drawing is provided for reference only

Part Number

**WES397**

Wescon 397 Microstop

Image 2



Part Number	Material
39631-N	Nylon
39631-S	Steel
39631-P	Phenolic

**Foot Style For External Thread**



Part Number	Material
39620-N	Nylon
39620-S	Steel
39620-P	Phenolic

**Foot Style For Internal Thread**



Part Number

**WES397**

Do not modify, copy, distribute, or reproduce this drawing without prior written authorization.

© 2025 Wescon Industries Inc.  
601 Century Plaza Dr. Houston, TX 77073, US  
www.wesconusa.com

Wescon 397 Microstop

Revision 05

All dimensions are in Inches

Information in this drawing is provided for reference only

Image 3