

DATASHEET

PART NUMBER

WES5501-1899

**Wescon 5501 Threaded Drill Bushing - 3/8-16 OD
Thread - Size 0.1899in**

Maximum I.D. .2570". Made of Hardened Steel. Exclusive Hex Socket Head for easier installation and removal.

WEBSITE

<https://www.wesconusa.com/products/WES5501-1899>



* The image represents the general look of the series. Actual product may vary based on options selected.

Wescon 5501 Threaded Drill Bushings are made of hardened steel for long life and accurate performance. The exclusive hex socket head design allows for easier installation and removal using a standard Allen wrench. These bushings are ideal for guiding drills in various machining applications, ensuring precision and reducing wear on the drill bit. Suitable for use with WES5601 Mini Drill Guides, WES5701-1 Egg Cup Drill Guides, and WES5900-1 Drill Bars.

SPECIFICATIONS

Measurement Type	Imperial
Thread Size	3/8-16
Size (ID)	0.1899in
Country of Origin	USA

ADDITIONAL IMAGES AND DRAWINGS

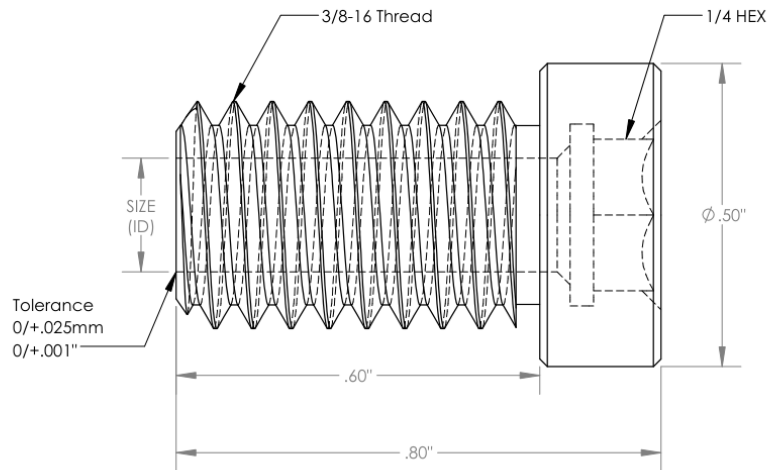

Image 1



Image 2

WES5501 Series Threaded Drill Bushing



Maximum Size (ID): 0.2570in

Order as P/N WES5501-(SIZE)
See wesconusa.com for full list of available sizes and part numbers.
Custom size available upon request.



Notes from our Engineering Team

- Hardened steel construction featuring a hex socket for quick and easy installation.
- WES5501 is most effective when paired with our WES5620/WES5720 Drill Guides or WES5900 Drill Bars



Part Number

WES5501 Series

Do not modify, copy, distribute, or reproduce this drawing without prior written authorization.

© 2025 Wescon Industries Inc.
601 Century Plaza Dr. Houston, TX 77073, US
www.wesconusa.com

Threaded Drill Bushing

Revision 04 All dimensions are in Inches Information in this drawing is provided for reference only

Image 3