

DATASHEET

PART NUMBER

WES5501-26

**Wescon 5501 Drill Bushing - 3/8-16 Thread -
Size #26 (0.1470in)**

Maximum I.D. .2570". Made of Hardened Steel. Exclusive
Hex Socket Head for easier installation and removal.

WEBSITE

<https://www.wesconusa.com/products/WES5501-26>



* The image represents the general look of the series. Actual product may vary based on options selected.

Wescon 5501 Threaded Drill Bushings are made of hardened steel for long life and accurate performance. The exclusive hex socket head design allows for easier installation and removal using a standard Allen wrench. These bushings are ideal for guiding drills in various machining applications, ensuring precision and reducing wear on the drill bit. Suitable for use with WES5601 Mini Drill Guides, WES5701-1 Egg Cup Drill Guides, and WES5900-1 Drill Bars.

SPECIFICATIONS

Thread Size	3/8-16
Size (ID)	#26 (0.1470in)
Country of Origin	USA

ADDITIONAL IMAGES AND DRAWINGS

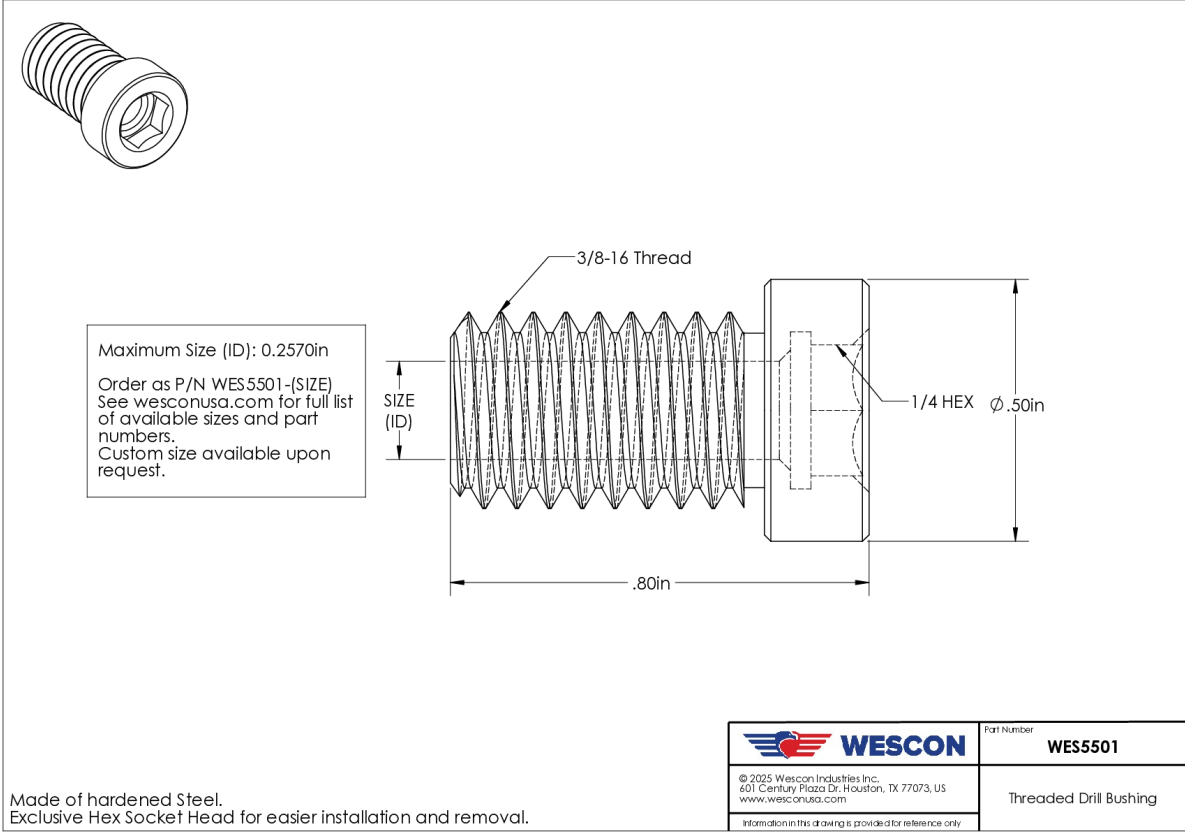

Image 1