

DATASHEET

PART NUMBER

WES5502-M630

**Wescon 5502 Drill Bushing - 1/2-13 Thread -
Size 6.30 mm**

Maximum I.D. .3125". Made of Hardened Steel. Exclusive
Hex Socket Head for easier installation and removal.

WEBSITE

<https://www.wesconusa.com/products/WES5502-M630>



* The image represents the general look of the series. Actual product may vary based on options selected.

Wescon 5502 Threaded Drill Bushings are constructed from hardened steel to ensure durability and precision in guiding drills. The unique hex socket head design facilitates easy installation and removal with a standard Allen wrench. These bushings are perfect for various machining tasks, providing accurate guidance and minimizing drill bit wear. Compatible with WES5602 Mini Drill Guides, WES5702-A Egg Cup Drill Guides, and WES5900-2 Drill Bars.

SPECIFICATIONS

Thread Size	1/2-13
Size (ID)	6.30 mm
Country of Origin	USA

ADDITIONAL IMAGES AND DRAWINGS

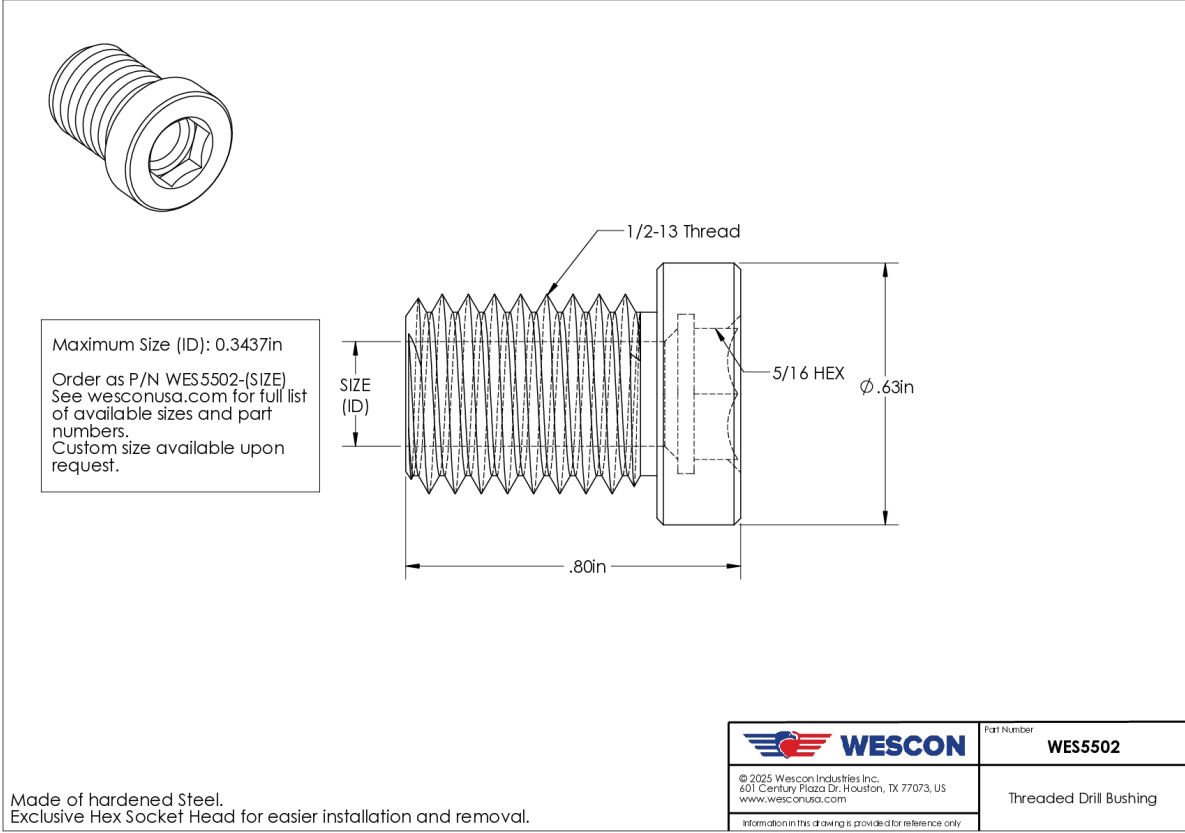

Image 1