

DATASHEET

PART NUMBER

WES5502-M710

**Wescon 5502 Threaded Drill Bushing - 1/2-13 OD
Thread - Size 7.10 mm**

Maximum I.D. .3125". Made of Hardened Steel. Exclusive Hex Socket Head for easier installation and removal.

WEBSITE

<https://www.wesconusa.com/products/WES5502-M710>



* The image represents the general look of the series. Actual product may vary based on options selected.

Wescon 5502 Threaded Drill Bushings are constructed from hardened steel to ensure durability and precision in guiding drills. The unique hex socket head design facilitates easy installation and removal with a standard Allen wrench. These bushings are perfect for various machining tasks, providing accurate guidance and minimizing drill bit wear. Compatible with WES5602 Mini Drill Guides, WES5702-A Egg Cup Drill Guides, and WES5900-2 Drill Bars.

SPECIFICATIONS

Measurement Type	Metric
Thread Size	1/2-13
Size (ID)	7.10 mm
Country of Origin	USA

ADDITIONAL IMAGES AND DRAWINGS

WES5502 Series Threaded Drill Bushing

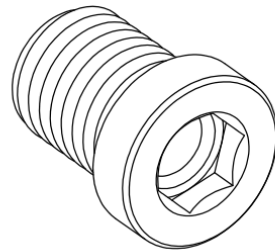
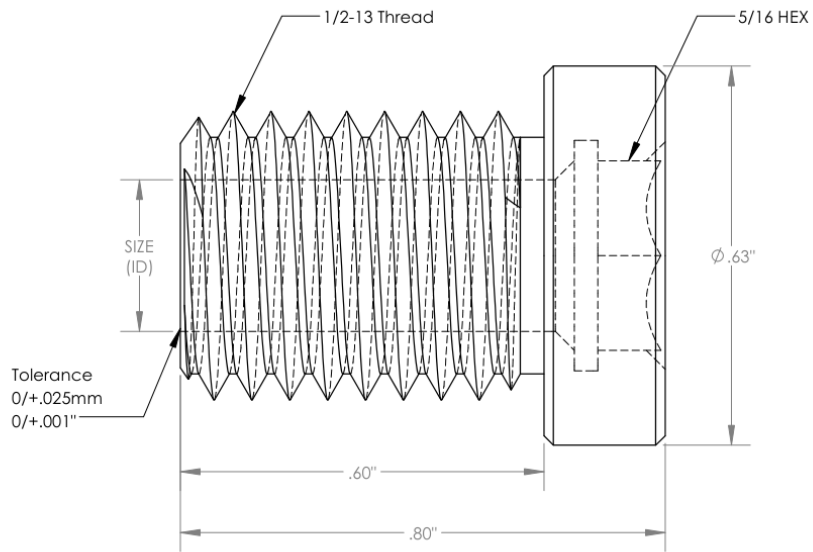

Maximum Size (ID): 0.3125in

Order as P/N WES5502-(SIZE)
See wesconusa.com for full list of available sizes and part numbers.
Custom size available upon request.



Notes from our Engineering Team

- Hardened steel construction featuring a hex socket for quick and easy installation.
- WES5502 is most effective when paired with our WES5620/WES5720 Drill Guides or WES5900 Drill Bars



Part Number

WES5502 Series

Do not modify, copy, distribute, or reproduce this drawing without prior written authorization.

© 2025 Wescon Industries Inc.
601 Century Plaza Dr. Houston, TX 77073, US
www.wesconusa.com

Threaded Drill Bushing

Revision 04

All dimensions are in Inches

Information in this drawing is provided for reference only

Image 1