

DATASHEET

PART NUMBER

WES596-6-WVEP

**Wescon 596 Microstop - M6x1 - 15.88 mm
Cutter Capacity - Vacuum External Thread
Skirt - Phenolic Foot**

HIGH SPEED HEAVY DUTY

WEBSITE

<https://www.wesconusa.com/products/WES596-6-WVEP>



* The image represents the general look of the series. Actual product may vary based on options selected.

SPECIFICATIONS

Measurement Type	Metric
Bearing Rating	10,000 rpm
Bearing Type	Dual Ball Bearings
Heavy Duty Thrust Bearing	Yes
Incremental Adjustment	0.013 mm
Shaft Travel	7.60 mm
Dust Seal	Integrated Dust Seal
Cutter Thread	M6x1
Shaft	Round
Shaft Diameter	6.35 mm
Cutter Capacity	15.88 mm
Skirt	Vacuum External Thread
Skirt Description	31.75 mm OD 21.996 mm ID 15.88 mm Cutter Capacity
Foot	Phenolic
Solid Stop	Yes
Material	Steel
Vacuum Adapter	Yes

Country of Origin

USA

ADDITIONAL IMAGES AND DRAWINGS

WES596 Series Microstop



Part Number
WES596-X-XX-XX

- Shaft Option
- Foot Style
- Skirt Option*
- Cutter Thread

Code	Cutter Thread
(Blank)	1/4-28
6	M6x1
8	M8x1

Code	Foot Style
N	Nylon
S	Steel
P	Phenolic

Code	Shaft Option
(Blank)	1/4in Standard Round
QC	Quick Change
TF	Tri Flat
TSL	1/4-28in Threaded Shank Long

Incremental Adjustment: 0.0005 in
 Shaft Travel: 0.300 in
 Material: Carbon Steel Body with Hardened Tool Steel Shaft

Bearing Rating: 10,000 rpm
 Bearing Type: Dual Ball-Bearings
 Dust Seal: Integrated Dust Seal
 Heavy Duty Thrust Bearing: Yes
 Solid Stop: Yes



*For Skirt options see next page and website.



WESCON

Part Number **WES596**

Wescon 596 Microstop

Revision 05

All dimensions are in inches

Information in this drawing is provided for reference only

Do not modify, copy, distribute, or reproduce this drawing without prior written authorization.

© 2025 Wescon Industries Inc.
 601 Century Plaza Dr. Houston, TX 77073, US
 www.wesconusa.com

Image 1

Skirt Option (Continuation)

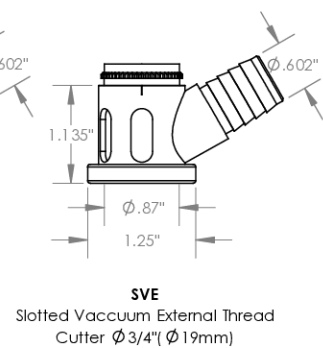
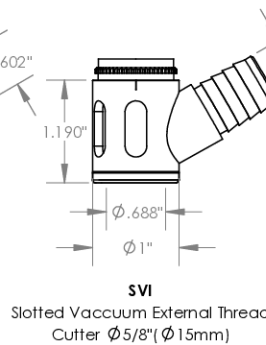
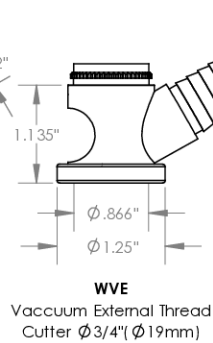
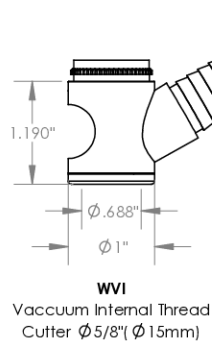
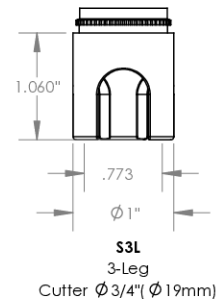
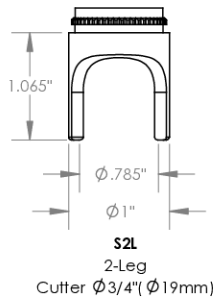
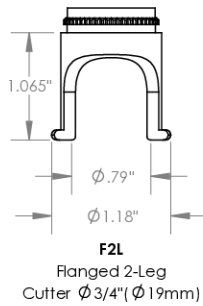
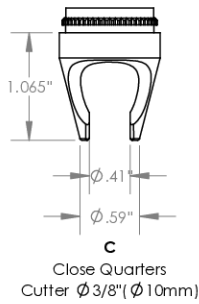
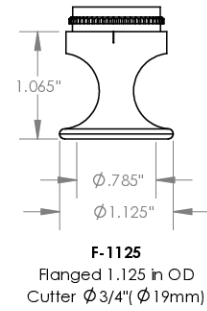
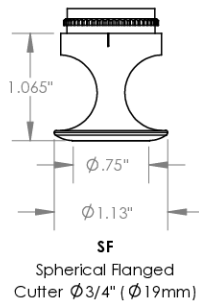
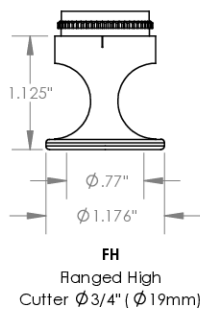
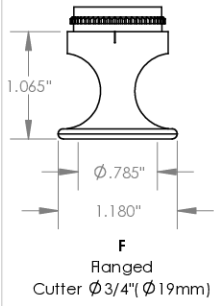

		Part Number	WES596
		Wescon 596 Microstop	
Revision 05	All dimensions are in inches	Information in this drawing is provided for reference only	
Do not modify, copy, distribute, or reproduce this drawing without prior written authorization.		© 2025 Wescon Industries Inc. 601 Century Plaza Dr. Houston, TX 77073, US www.wesconusa.com	

Image 2

Skirt Option

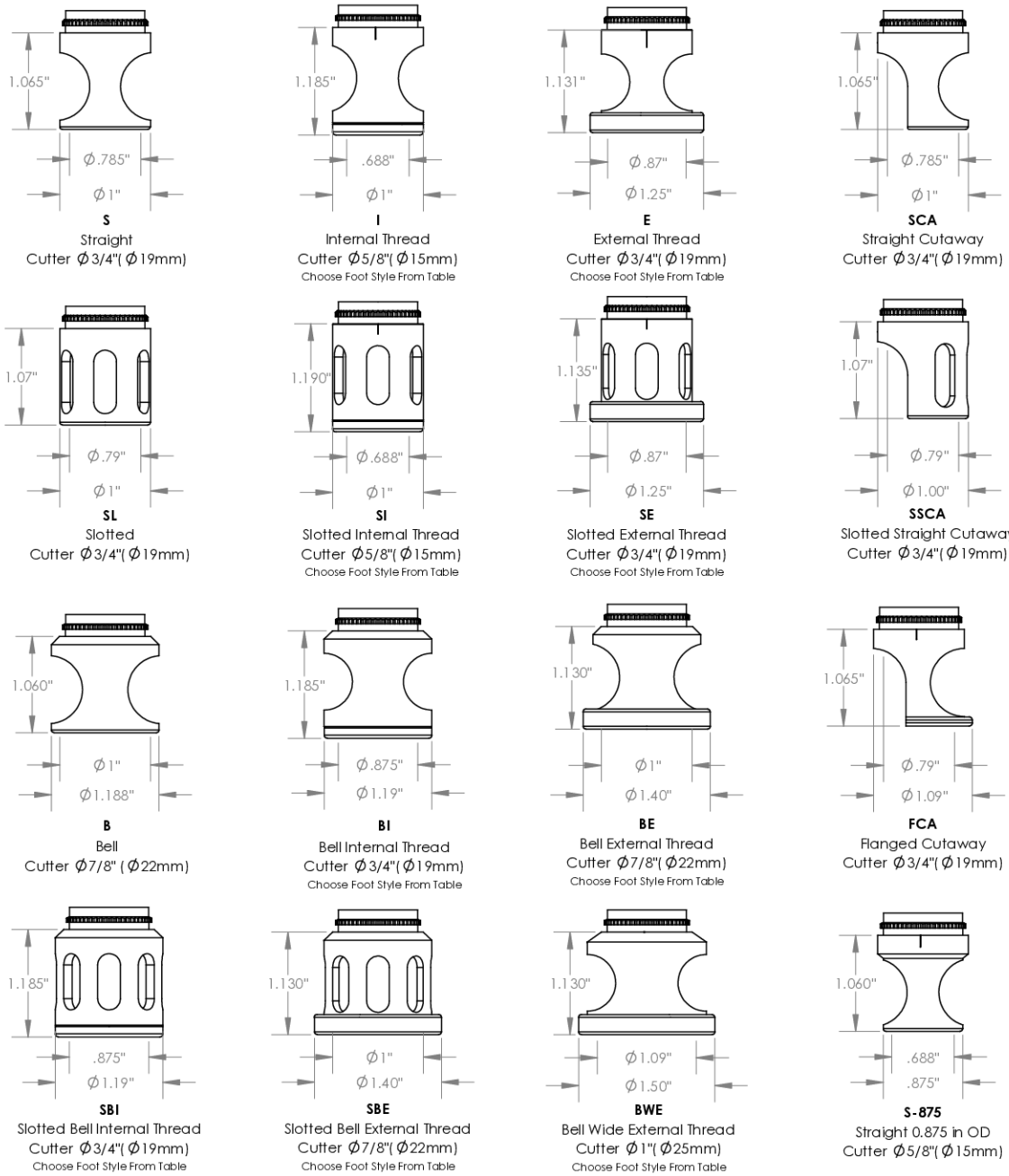

Continued In Next Page.

Revision 05

Do not modify, copy, distribute, or reproduce this drawing without prior written authorization.

© 2025 Wescon Industries Inc.
601 Century Plaza Dr. Houston, TX 77073, US
www.wesconusa.com

Information in this drawing is provided for reference only



Part Number

WES596

Wescon 596 Microstop

Image 3

**Foot Style
For External Thread**



Part Number	Material
59631-N	Nylon
59631-S	Steel
59631-P	Phenolic

**Foot Style
For Internal Thread**



Part Number	Material
59620-N	Nylon
59620-S	Steel
59620-P	Phenolic

**Foot Style
For Bell External Thread**



Part Number	Material
59641-N	Nylon
59641-S	Steel
59641-P	Phenolic

**Foot Style
For Bell Internal Thread**



Part Number	Material
59640-N	Nylon
59640-S	Steel
59640-P	Phenolic

**Foot Style
For Bell Wide External Thread**



Part Number	Material
59651-N	Nylon
59651-S	Steel
59651-P	Phenolic

		Part Number	WES596
		Wescon 596 Microstop	
Revision 05	All dimensions are in inches	Information in this drawing is provided for reference only	
Do not modify, copy, distribute, or reproduce this drawing without prior written authorization.		© 2025 Wescon Industries Inc. 601 Century Plaza Dr. Houston, TX 77073, US www.wesconusa.com	

Image 4