

## DATASHEET

PART NUMBER

# WES596-8-VS-QC

**Wescon 596 Microstop - M8x1 - 19.05 mm  
 Cutter Capacity - Vacuum Straight Skirt**

HIGH SPEED HEAVY DUTY

WEBSITE

<https://www.wesconusa.com/products/WES596-8-VS-QC>

\* The image represents the general look of the series. Actual product may vary based on options selected.

## SPECIFICATIONS

<b>Measurement Type</b>	Metric
<b>Bearing Rating</b>	10,000 rpm
<b>Bearing Type</b>	Dual Ball Bearings
<b>Heavy Duty Thrust Bearing</b>	Yes
<b>Incremental Adjustment</b>	0.013 mm
<b>Shaft Travel</b>	7.60 mm
<b>Dust Seal</b>	Integrated Dust Seal
<b>Cutter Thread</b>	M8x1
<b>Shaft</b>	Quick Change
<b>Shaft Diameter</b>	6.35 mm
<b>Cutter Capacity</b>	19.05 mm
<b>Skirt</b>	Vacuum Straight
<b>Skirt Description</b>	25.4 mm OD 22.01 mm ID 19.05 mm Cutter Capacity
<b>Solid Stop</b>	Yes
<b>Material</b>	Steel
<b>Vacuum Adapter</b>	Yes
<b>Country of Origin</b>	USA

**ADDITIONAL IMAGES AND DRAWINGS**

**WES596 Series Microstop**



**Part Number**  
WES596-X-XX-XX



Code	Cutter Thread
(Blank)	1/4-28
6	M6x1
8	M8x1

Code	Foot Style
N	Nylon
S	Steel
P	Phenolic

Code	Shaft Option
(Blank)	1/4in Standard Round
QC	Quick Change
TF	Tri Flat
TSL	1/4-28in Threaded Shank Long

Incremental Adjustment: 0.0005 in  
 Shaft Travel: 0.300 in  
 Material: Carbon Steel Body with Hardened Tool Steel Shaft

Bearing Rating: 10,000 rpm  
 Bearing Type: Dual Ball-Bearings  
 Dust Seal: Integrated Dust Seal  
 Heavy Duty Thrust Bearing: Yes  
 Solid Stop: Yes

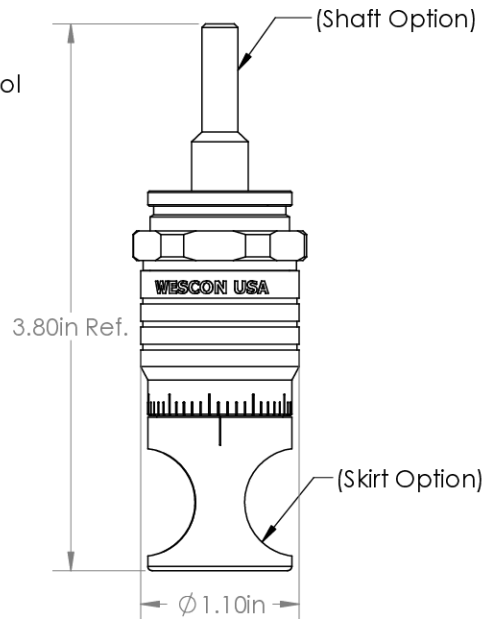

\*For Skirt options see next page and website.



Part Number

**WES596**

Do not modify, copy, distribute, or reproduce this drawing without prior written authorization.

© 2025 Wescon Industries Inc.  
 601 Century Plaza Dr. Houston, TX 77073, US  
 www.wesconusa.com

Wescon 596 Microstop

Revision 05

All dimensions are in inches

Information in this drawing is provided for reference only

Image 1

### Skirt Option (Continuation)

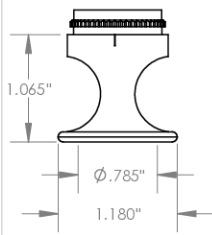

**F**  
Ranged  
Cutter  $\phi 3/4\text{''}$  ( $\phi 19\text{mm}$ )



**FH**  
Ranged High  
Cutter  $\phi 3/4\text{''}$  ( $\phi 19\text{mm}$ )



**SF**  
Spherical Ranged  
Cutter  $\phi 3/4\text{''}$  ( $\phi 19\text{mm}$ )



**F-1125**  
Ranged 1.125 in OD  
Cutter  $\phi 3/4\text{''}$  ( $\phi 19\text{mm}$ )

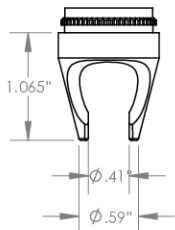

**C**  
Close Quarters  
Cutter  $\phi 3/8\text{''}$  ( $\phi 10\text{mm}$ )

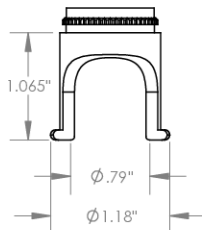

**F2L**  
Flanged 2-Leg  
Cutter  $\phi 3/4\text{''}$  ( $\phi 19\text{mm}$ )

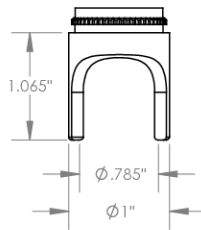

**S2L**  
2-Leg  
Cutter  $\phi 3/4\text{''}$  ( $\phi 19\text{mm}$ )

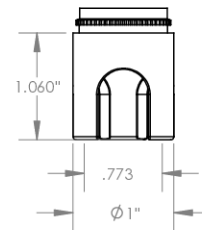

**S3L**  
3-Leg  
Cutter  $\phi 3/4\text{''}$  ( $\phi 19\text{mm}$ )

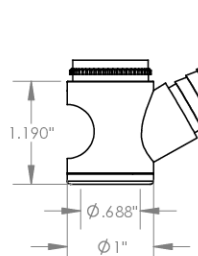

**WVI**  
Vacuum Internal Thread  
Cutter  $\phi 5/8\text{''}$  ( $\phi 15\text{mm}$ )



**WVE**  
Vacuum External Thread  
Cutter  $\phi 3/4\text{''}$  ( $\phi 19\text{mm}$ )

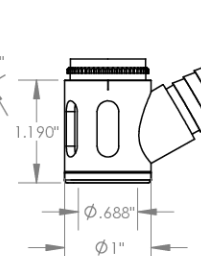

**SVI**  
Slotted Vacuum External Thread  
Cutter  $\phi 5/8\text{''}$  ( $\phi 15\text{mm}$ )



**SVE**  
Slotted Vacuum External Thread  
Cutter  $\phi 3/4\text{''}$  ( $\phi 19\text{mm}$ )



Part Number

**WES596**

Do not modify, copy, distribute, or reproduce this drawing without prior written authorization.

© 2025 Wescon Industries Inc.  
601 Century Plaza Dr. Houston, TX 77073, US  
www.wesconusa.com

Wescon 596 Microstop

Revision 05

All dimensions are in inches

Information in this drawing is provided for reference only

Image 2

### Skirt Option



Continued In Next Page.

Revision 05

Do not modify, copy, distribute, or reproduce this drawing without prior written authorization.

© 2025 Wescon Industries Inc.  
601 Century Plaza Dr. Houston, TX 77073, US  
www.wesconusa.com

Information in this drawing is provided for reference only



Part Number

**WES596**

Wescon 596 Microstop

Image 3

**Foot Style  
For External Thread**



Part Number	Material
59631-N	Nylon
59631-S	Steel
59631-P	Phenolic

**Foot Style  
For Internal Thread**



Part Number	Material
59620-N	Nylon
59620-S	Steel
59620-P	Phenolic

**Foot Style  
For Bell External Thread**



Part Number	Material
59641-N	Nylon
59641-S	Steel
59641-P	Phenolic

**Foot Style  
For Bell Internal Thread**



Part Number	Material
59640-N	Nylon
59640-S	Steel
59640-P	Phenolic

**Foot Style  
For Bell Wide External Thread**



Part Number	Material
59651-N	Nylon
59651-S	Steel
59651-P	Phenolic

		Part Number	<b>WES596</b>
		Wescon 596 Microstop	
Revision 05	All dimensions are in inches	Information in this drawing is provided for reference only	
Do not modify, copy, distribute, or reproduce this drawing without prior written authorization.		© 2025 Wescon Industries Inc. 601 Century Plaza Dr. Houston, TX 77073, US www.wesconusa.com	

Image 4