

## DATASHEET

PART NUMBER

# WES596-8-WVES

**Wescon 596 Microstop - M8x1 - 19 mm Cutter  
Capacity - Vacuum Skirt External Steel Foot**

HIGH SPEED HEAVY DUTY

WEBSITE

<https://www.wesconusa.com/products/WES596-8-WVES>

\* The image represents the general look of the series. Actual product may vary based on options selected.

## SPECIFICATIONS

<b>Measurement Type</b>	Metric
<b>Bearing Rating</b>	10,000 rpm
<b>Bearing Type</b>	Dual Ball Bearings
<b>Heavy Duty Thrust Bearing</b>	Yes
<b>Incremental Adjustment</b>	0.013 mm
<b>Shaft Travel</b>	7.60 mm
<b>Dust Seal</b>	Integrated Dust Seal
<b>Cutter Thread</b>	M8x1
<b>Shaft</b>	Round
<b>Shaft Diameter</b>	6.35 mm
<b>Cutter Capacity</b>	19 mm
<b>Skirt</b>	Vacuum External Thread
<b>Skirt Description</b>	31.75 mm OD 21.996 mm ID 19 mm Cutter Capacity
<b>Foot</b>	Steel
<b>Solid Stop</b>	Yes
<b>Material</b>	Steel
<b>Vacuum Adapter</b>	Yes

**ADDITIONAL IMAGES AND DRAWINGS**

**WES596 Series Microstop**



**Part Number**  
WES596-X-XX-XX



Incremental Adjustment: 0.0005 in  
Shaft Travel: 0.300 in  
Material: Carbon Steel Body with  
Hardened Tool Steel Shaft

Bearing Rating: 10,000 rpm  
Bearing Type: Dual Ball-Bearings  
Dust Seal: Integrated Dust Seal  
Heavy Duty Thrust Bearing: Yes  
Solid Stop: Yes

Code	Cutter Thread
(Blank)	1/4-28
6	M6x1
8	M8x1

Code	Foot Style
N	Nylon
S	Steel
P	Phenolic

Code	Shaft Option
(Blank)	1/4" Standard Round
QC	Quick Change
TF	Tri Flat
TSL	1/4-28 Threaded Shank Long



**WES596-S**  
Microstop with  
Ø 1/4" Standard Shaft



**WES596-SL-TF**  
Microstop with  
Tri-Flat Shaft



**WES596-SCA-TSL**  
Microstop with  
1/4-28 Threaded Shank Long Shaft



**WES596-S3L-QC**  
Microstop with  
Quick Change shaft

\*For Skirt options see next page and website.



Part Number

**WES596**

Do not modify, copy, distribute, or reproduce this drawing without prior written authorization.

© 2025 Wescon Industries Inc.  
601 Century Plaza Dr, Houston, TX 77073, US  
www.wesconusa.com

Wescon 596 Microstop

Revision 09 All dimensions are in Inches Information in this drawing is provided for reference only

Image 1

### Skirt Option



**S**  
Straight  
Cutter  $\phi 3/4"$  ( $\phi 19\text{mm}$ )



**I**  
Internal Thread\*  
Cutter  $\phi 5/8"$  ( $\phi 15\text{mm}$ )



**E**  
External Thread\*  
Cutter  $\phi 3/4"$  ( $\phi 19\text{mm}$ )



**SCA**  
Straight Cutaway  
Cutter  $\phi 3/4"$  ( $\phi 19\text{mm}$ )



**SL**  
Slotted  
Cutter  $\phi 3/4"$  ( $\phi 19\text{mm}$ )



**SI**  
Slotted Internal Thread\*  
Cutter  $\phi 5/8"$  ( $\phi 15\text{mm}$ )



**SE**  
Slotted External Thread\*  
Cutter  $\phi 3/4"$  ( $\phi 19\text{mm}$ )



**SSCA**  
Slotted Straight Cutaway  
Cutter  $\phi 3/4"$  ( $\phi 19\text{mm}$ )



**B**  
Bell  
Cutter  $\phi 7/8"$  ( $\phi 22\text{mm}$ )



**BI**  
Bell Internal Thread\*  
Cutter  $\phi 3/4"$  ( $\phi 19\text{mm}$ )



**BE**  
Bell External Thread\*  
Cutter  $\phi 7/8"$  ( $\phi 22\text{mm}$ )



**FCA**  
Flanged Cutaway  
Cutter  $\phi 3/4"$  ( $\phi 19\text{mm}$ )



**SBI**  
Slotted Bell Internal Thread\*  
Cutter  $\phi 3/4"$  ( $\phi 19\text{mm}$ )



**SBE**  
Slotted Bell External Thread\*  
Cutter  $\phi 7/8"$  ( $\phi 22\text{mm}$ )



**BWE**  
Bell Wide External Thread\*  
Cutter  $\phi 1"$  ( $\phi 25\text{mm}$ )



**S-875**  
Straight 0.875 in OD  
Cutter  $\phi 5/8"$  ( $\phi 15\text{mm}$ )



Part Number

**WES596**

\*Select foot style from table  
Continued In Next Page.

Do not modify, copy, distribute, or reproduce this drawing without prior written authorization.

© 2025 Wescon Industries Inc.  
601 Century Plaza Dr. Houston, TX 77073, US  
www.wesconusa.com

Wescon 596 Microstop

Revision 09

All dimensions are in Inches

Information in this drawing is provided for reference only

Image 2

### Skirt Option (Continuation)



**F**  
Flanged  
Cutter  $\Phi 3/4"$  ( $\Phi 19\text{mm}$ )



**FH**  
Flanged High  
Cutter  $\Phi 3/4"$  ( $\Phi 19\text{mm}$ )

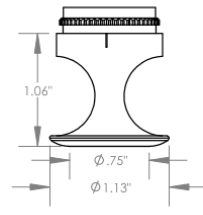

**SF**  
Spherical Flanged  
Cutter  $\Phi 3/4"$  ( $\Phi 19\text{mm}$ )



**F-1125**  
Flanged 1.125 in OD  
Cutter  $\Phi 3/4"$  ( $\Phi 19\text{mm}$ )



**C**  
Close Quarters  
Cutter  $\Phi 3/8"$  ( $\Phi 10\text{mm}$ )



**F2L**  
Flanged 2-Leg  
Cutter  $\Phi 3/4"$  ( $\Phi 19\text{mm}$ )

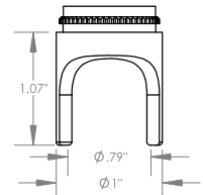

**S2L**  
2-Leg  
Cutter  $\Phi 3/4"$  ( $\Phi 19\text{mm}$ )



**S3L**  
3-Leg  
Cutter  $\Phi 3/4"$  ( $\Phi 19\text{mm}$ )



**WVI**  
Vacuum Internal Thread\*  
Cutter  $\Phi 5/8"$  ( $\Phi 15\text{mm}$ )



**WVE**  
Vacuum External Thread\*  
Cutter  $\Phi 3/4"$  ( $\Phi 19\text{mm}$ )

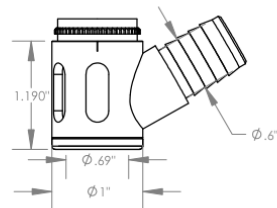

**SVI**  
Slotted Vacuum Internal Thread\*  
Cutter  $\Phi 5/8"$  ( $\Phi 15\text{mm}$ )



**SVE**  
Slotted Vacuum External Thread\*  
Cutter  $\Phi 3/4"$  ( $\Phi 19\text{mm}$ )



**WVS**  
Vacuum Straight  
Cutter  $\Phi 3/4"$  ( $\Phi 19\text{mm}$ )



**SVS**  
Slotted Vacuum Straight  
Cutter  $\Phi 3/4"$  ( $\Phi 19\text{mm}$ )

\*Select foot style from table

			Part Number	<b>WES596</b>
		© 2025 Wescon Industries Inc. 601 Century Plaza Dr. Houston, TX 77073, US www.wesconusa.com		Wescon 596 Microstop
Revision 09	All dimensions are in Inches	Information in this drawing is provided for reference only		

Image 3

### Skirt Option



**VS**  
Vacuum Straight  
Cutter  $\Phi 3/4"$  ( $\Phi 19\text{mm}$ )



**VE**  
Vacuum External Thread\*  
Cutter  $\Phi 3/4"$  ( $\Phi 19\text{mm}$ )



**VI**  
Vacuum Internal Thread\*  
Cutter  $\Phi 5/8"$  ( $\Phi 15\text{mm}$ )



Part Number	Material
59631-N	Nylon
59631-S	Steel
59631-P	Phenolic

**Foot Style For External Thread**



Part Number	Material
59620-N	Nylon
59620-S	Steel
59620-P	Phenolic

**Foot Style For Internal Thread**



Part Number	Material
59641-N	Nylon
59641-S	Steel
59641-P	Phenolic

**Foot Style For Bell External Thread**



Part Number	Material
59640-N	Nylon
59640-S	Steel
59640-P	Phenolic

**Foot Style For Bell Internal Thread**



Part Number	Material
59651-N	Nylon
59651-S	Steel
59651-P	Phenolic

**Foot Style For Bell Wide External Thread**

\*Select foot style from table

Revision 09

Do not modify, copy, distribute, or reproduce this drawing without prior written authorization.

All dimensions are in Inches



© 2025 Wescon Industries Inc.  
601 Century Plaza Dr. Houston, TX 77073, US  
www.wesconusa.com

Information in this drawing is provided for reference only

Part Number

**WES596**

**Wescon 596 Microstop**

Image 4