

DATASHEET

PART NUMBER

WES596-BES-TSL

**Wescon 596 Microstop - 1/4-28 - 7/8" Cutter
Capacity - Bell Skirt External Steel Foot**

HIGH SPEED HEAVY DUTY

WEBSITE

<https://www.wesconusa.com/products/WES596-BES-TSL>



* The image represents the general look of the series. Actual product may vary based on options selected.

SPECIFICATIONS

| | |
|----------------------------------|----------------------------------|
| Measurement Type | Imperial |
| Bearing Rating | 10,000 rpm |
| Bearing Type | Dual Ball Bearings |
| Heavy Duty Thrust Bearing | Yes |
| Incremental Adjustment | 0.0005 in |
| Shaft Travel | 0.300 in |
| Dust Seal | Integrated Dust Seal |
| Cutter Thread | 1/4-28 |
| Shaft | Threaded Shank Long (1/4-28) |
| Shaft Diameter | 1/4 in |
| Cutter Capacity | 7/8 in |
| Skirt | Bell External Thread |
| Skirt Description | 1.4 in OD 7/8 in Cutter Capacity |
| Foot | Steel |
| Solid Stop | Yes |
| Material | Steel |
| Country of Origin | USA |

ADDITIONAL IMAGES AND DRAWINGS

WES596 Series Microstop



Part Number
WES596-X-XX-XX

- Shaft Option
- Foot Style
- Skirt Option*
- Cutter Thread

| Code | Cutter Thread |
|---------|---------------|
| (Blank) | 1/4-28 |
| 6 | M6x1 |
| 8 | M8x1 |

| Code | Foot Style |
|------|------------|
| N | Nylon |
| S | Steel |
| P | Phenolic |

| Code | Shaft Option |
|---------|------------------------------|
| (Blank) | 1/4in Standard Round |
| QC | Quick Change |
| TF | Tri Flat |
| TSL | 1/4-28in Threaded Shank Long |

Incremental Adjustment: 0.0005 in
 Shaft Travel: 0.300 in
 Material: Carbon Steel Body with Hardened Tool Steel Shaft

Bearing Rating: 10,000 rpm
 Bearing Type: Dual Ball-Bearings
 Dust Seal: Integrated Dust Seal
 Heavy Duty Thrust Bearing: Yes
 Solid Stop: Yes

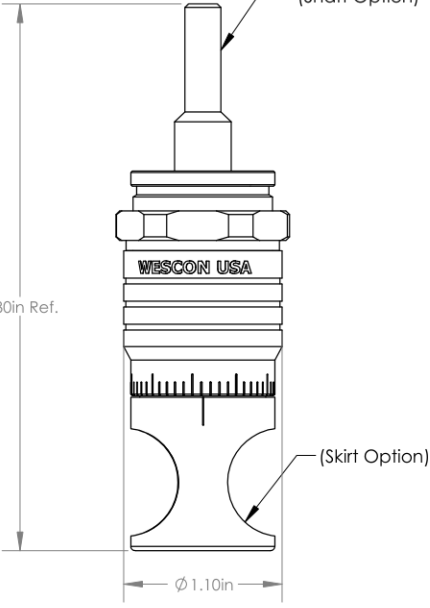

*For Skirt options see next page and website.

| | |
|---|---|
|  | Part Number WES596 |
| © 2025 Wescon Industries Inc. 601 Century Plaza Dr. Houston, TX 77073. US www.wesconusa.com | Wescon 596 Microstop |
| Revision 09 | All dimensions are in Inches Information in this drawing is provided for reference only |

Image 1

Skirt Option



S
Straight
Cutter $\phi 3/4"$ ($\phi 19\text{mm}$)

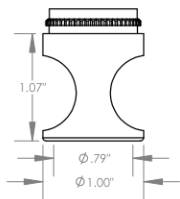
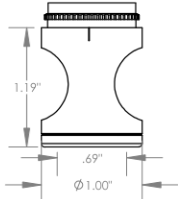

I
Internal Thread*
Cutter $\phi 5/8"$ ($\phi 15\text{mm}$)

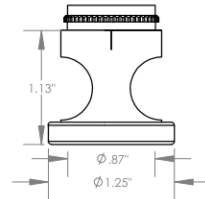

E
External Thread*
Cutter $\phi 3/4"$ ($\phi 19\text{mm}$)

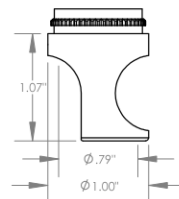

SCA
Straight Cutaway
Cutter $\phi 3/4"$ ($\phi 19\text{mm}$)

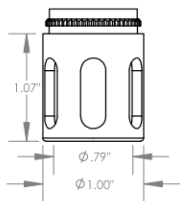

SL
Slotted
Cutter $\phi 3/4"$ ($\phi 19\text{mm}$)

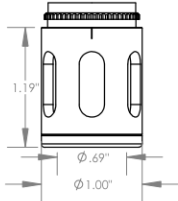

SI
Slotted Internal Thread*
Cutter $\phi 5/8"$ ($\phi 15\text{mm}$)

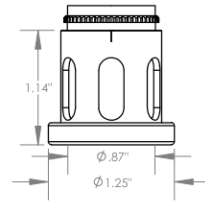

SE
Slotted External Thread*
Cutter $\phi 3/4"$ ($\phi 19\text{mm}$)

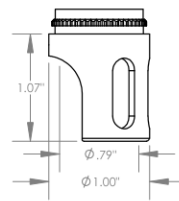

SSCA
Slotted Straight Cutaway
Cutter $\phi 3/4"$ ($\phi 19\text{mm}$)

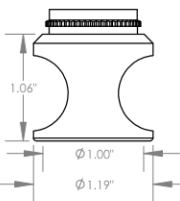

B
Bell
Cutter $\phi 7/8"$ ($\phi 22\text{mm}$)

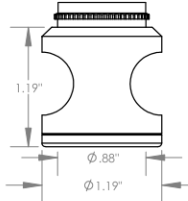

BI
Bell Internal Thread*
Cutter $\phi 3/4"$ ($\phi 19\text{mm}$)

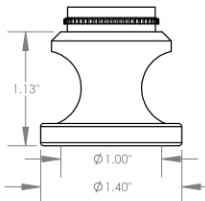

BE
Bell External Thread*
Cutter $\phi 7/8"$ ($\phi 22\text{mm}$)

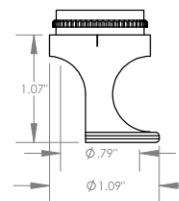

FCA
Flanged Cutaway
Cutter $\phi 3/4"$ ($\phi 19\text{mm}$)

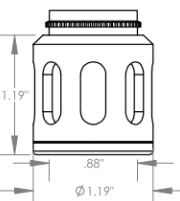

SBI
Slotted Bell Internal Thread*
Cutter $\phi 3/4"$ ($\phi 19\text{mm}$)

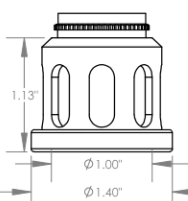

SBE
Slotted Bell External Thread*
Cutter $\phi 7/8"$ ($\phi 22\text{mm}$)

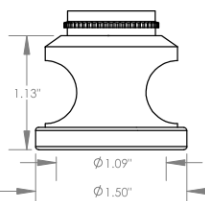

BWE
Bell Wide External Thread*
Cutter $\phi 1"$ ($\phi 25\text{mm}$)

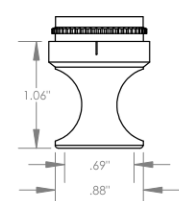

S-875
Straight 0.875 in OD
Cutter $\phi 5/8"$ ($\phi 15\text{mm}$)



Part Number

WES596

*Select foot style from table
Continued In Next Page.

Do not modify, copy, distribute, or reproduce this drawing without prior written authorization.

© 2025 Wescon Industries Inc.
601 Century Plaza Dr. Houston, TX 77073, US
www.wesconusa.com

Wescon 596 Microstop

Revision 09

All dimensions are in inches

Information in this drawing is provided for reference only

Image 2

Skirt Option (Continuation)

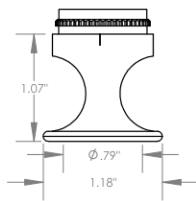

F
Flanged
Cutter $\phi 3/4"$ ($\phi 19\text{mm}$)

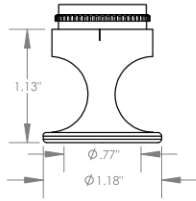

FH
Flanged High
Cutter $\phi 3/4"$ ($\phi 19\text{mm}$)

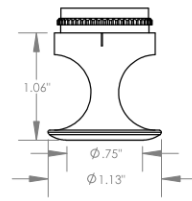

SF
Spherical Flanged
Cutter $\phi 3/4"$ ($\phi 19\text{mm}$)

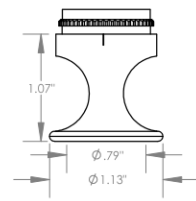

F-1125
Flanged 1.125 in OD
Cutter $\phi 3/4"$ ($\phi 19\text{mm}$)

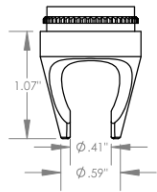

C
Close Quarters
Cutter $\phi 3/8"$ ($\phi 10\text{mm}$)

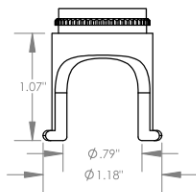

F2L
Flanged 2-Leg
Cutter $\phi 3/4"$ ($\phi 19\text{mm}$)

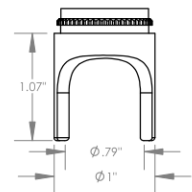

S2L
2-Leg
Cutter $\phi 3/4"$ ($\phi 19\text{mm}$)

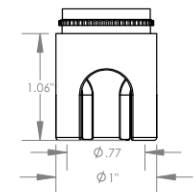

S3L
3-Leg
Cutter $\phi 3/4"$ ($\phi 19\text{mm}$)

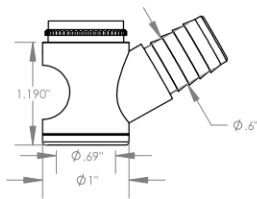

WVI
Vacuum Internal Thread*
Cutter $\phi 5/8"$ ($\phi 15\text{mm}$)

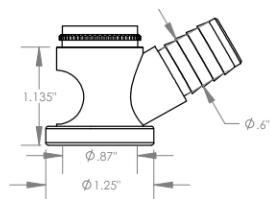

WVE
Vacuum External Thread*
Cutter $\phi 3/4"$ ($\phi 19\text{mm}$)

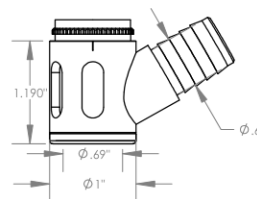

SVI
Slotted Vacuum Internal Thread*
Cutter $\phi 5/8"$ ($\phi 15\text{mm}$)

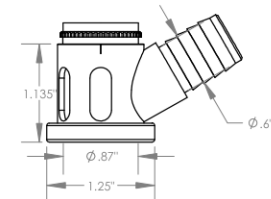

SVE
Slotted Vacuum External Thread*
Cutter $\phi 3/4"$ ($\phi 19\text{mm}$)

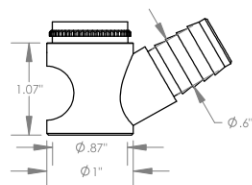

WVS
Vacuum Straight
Cutter $\phi 3/4"$ ($\phi 19\text{mm}$)

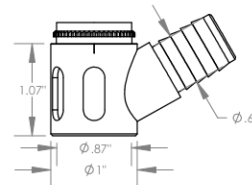

SVS
Slotted Vacuum Straight
Cutter $\phi 3/4"$ ($\phi 19\text{mm}$)



Part Number

WES596

Do not modify, copy, distribute, or reproduce this drawing without prior written authorization.

© 2025 Wescon Industries Inc.
601 Century Plaza Dr. Houston, TX 77073, US
www.wesconusa.com

Wescon 596 Microstop

*Select foot style from table

Revision 09

All dimensions are in inches

Information in this drawing is provided for reference only

Image 3

Skirt Option

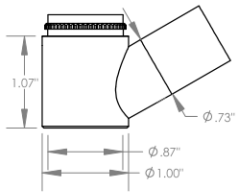

VS
Vacuum Straight
Cutter $\phi 3/4"$ ($\phi 19\text{mm}$)

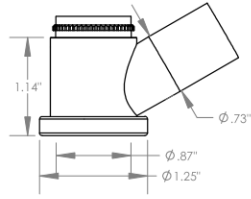

VE
Vacuum External Thread*
Cutter $\phi 3/4"$ ($\phi 19\text{mm}$)

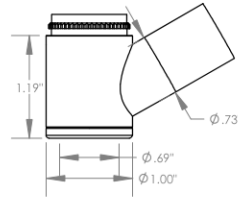

VI
Vacuum Internal Thread*
Cutter $\phi 5/8"$ ($\phi 15\text{mm}$)

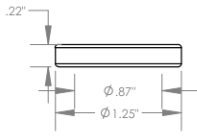

Foot Style For External Thread

| Part Number | Material |
|-------------|----------|
| 59631-N | Nylon |
| 59631-S | Steel |
| 59631-P | Phenolic |

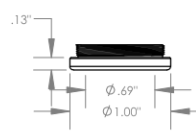

Foot Style For Internal Thread

| Part Number | Material |
|-------------|----------|
| 59620-N | Nylon |
| 59620-S | Steel |
| 59620-P | Phenolic |

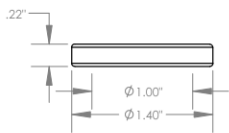

Foot Style For Bell External Thread

| Part Number | Material |
|-------------|----------|
| 59641-N | Nylon |
| 59641-S | Steel |
| 59641-P | Phenolic |

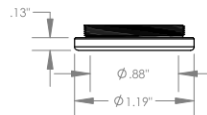

Foot Style For Bell Internal Thread

| Part Number | Material |
|-------------|----------|
| 59640-N | Nylon |
| 59640-S | Steel |
| 59640-P | Phenolic |

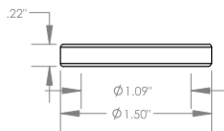

Foot Style For Bell Wide External Thread

| Part Number | Material |
|-------------|----------|
| 59651-N | Nylon |
| 59651-S | Steel |
| 59651-P | Phenolic |

*Select foot style from table

Revision 09

Do not modify, copy, distribute, or reproduce this drawing without prior written authorization.

All dimensions are in inches



© 2025 Wescon Industries Inc.
601 Century Plaza Dr. Houston, TX 77073, US
www.wesconusa.com

Part Number

WES596

Wescon 596 Microstop

Information in this drawing is provided for reference only

Image 4