

DATASHEET

PART NUMBER

WES596-SBES-TSL

Wescon 596 Microstop - 1/4-28 - 7/8" Cutter Capacity - Slotted Bell Skirt External Steel Foot

HIGH SPEED HEAVY DUTY

WEBSITE

<https://www.wesconusa.com/products/WES596-SBES-TSL>



* The image represents the general look of the series. Actual product may vary based on options selected.

SPECIFICATIONS

Measurement Type	Imperial
Bearing Rating	10,000 rpm
Bearing Type	Dual Ball Bearings
Heavy Duty Thrust Bearing	Yes
Incremental Adjustment	0.0005 in
Shaft Travel	0.300 in
Dust Seal	Integrated Dust Seal
Cutter Thread	1/4-28
Shaft	Threaded Shank Long (1/4-28)
Shaft Diameter	1/4 in
Cutter Capacity	7/8 in
Skirt	Slotted Bell External Thread
Skirt Description	1.4 in OD 7/8 in Cutter Capacity
Foot	Steel
Solid Stop	Yes
Material	Steel
Country of Origin	USA

ADDITIONAL IMAGES AND DRAWINGS



Image 0

WES596 Series Microstop



Part Number
WES596-X-XX-XX



Code	Cutter Thread
(Blank)	1/4-28
6	M6x1
8	M8x1

Code	Foot Style
N	Nylon
S	Steel
P	Phenolic

Code	Shaft Option
(Blank)	1/4in Standard Round
QC	Quick Change
TF	Tri Flat
TSL	1/4-28in Threaded Shank Long

Incremental Adjustment: 0.0005 in
 Shaft Travel: 0.300 in
 Material: Carbon Steel Body with Hardened Tool Steel Shaft

Bearing Rating: 10,000 rpm
 Bearing Type: Dual Ball-Bearings
 Dust Seal: Integrated Dust Seal
 Heavy Duty Thrust Bearing: Yes
 Solid Stop: Yes

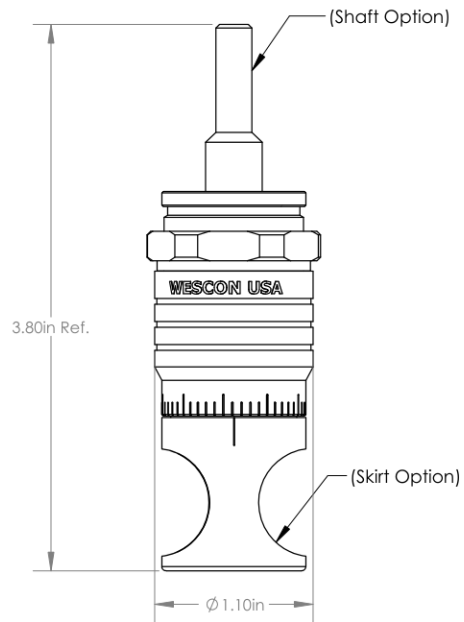

*For Skirt options see next page and website.



Part Number

WES596

Do not modify, copy, distribute, or reproduce this drawing without prior written authorization.

© 2025 Wescon Industries Inc.
 601 Century Plaza Dr. Houston, TX 77073, US
 www.wesconusa.com

Wescon 596 Microstop

Revision 09

All dimensions are in Inches

Information in this drawing is provided for reference only

Image 1

Skirt Option



S
Straight
Cutter $\phi 3/4"$ ($\phi 19\text{mm}$)



I
Internal Thread*
Cutter $\phi 5/8"$ ($\phi 15\text{mm}$)



E
External Thread*
Cutter $\phi 3/4"$ ($\phi 19\text{mm}$)



SCA
Straight Cutaway
Cutter $\phi 3/4"$ ($\phi 19\text{mm}$)



SL
Slotted
Cutter $\phi 3/4"$ ($\phi 19\text{mm}$)



SI
Slotted Internal Thread*
Cutter $\phi 5/8"$ ($\phi 15\text{mm}$)



SE
Slotted External Thread*
Cutter $\phi 3/4"$ ($\phi 19\text{mm}$)



SSCA
Slotted Straight Cutaway
Cutter $\phi 3/4"$ ($\phi 19\text{mm}$)



B
Bell
Cutter $\phi 7/8"$ ($\phi 22\text{mm}$)



BI
Bell Internal Thread*
Cutter $\phi 3/4"$ ($\phi 19\text{mm}$)



BE
Bell External Thread*
Cutter $\phi 7/8"$ ($\phi 22\text{mm}$)



FCA
Flanged Cutaway
Cutter $\phi 3/4"$ ($\phi 19\text{mm}$)



SBI
Slotted Bell Internal Thread*
Cutter $\phi 3/4"$ ($\phi 19\text{mm}$)



SBE
Slotted Bell External Thread*
Cutter $\phi 7/8"$ ($\phi 22\text{mm}$)



BWE
Bell Wide External Thread*
Cutter $\phi 1"$ ($\phi 25\text{mm}$)



S-875
Straight 0.875 in OD
Cutter $\phi 5/8"$ ($\phi 15\text{mm}$)



Part Number

WES596

*Select foot style from table
Continued In Next Page.

Do not modify, copy, distribute, or reproduce this drawing without prior written authorization.

© 2025 Wescon Industries Inc.
601 Century Plaza Dr. Houston, TX 77073, US
www.wesconusa.com

Wescon 596 Microstop

Revision 09

All dimensions are in inches

Information in this drawing is provided for reference only

Image 2

Skirt Option (Continuation)



F
Flanged
Cutter $\phi 3/4"$ ($\phi 19\text{mm}$)



FH
Flanged High
Cutter $\phi 3/4"$ ($\phi 19\text{mm}$)



SF
Spherical Flanged
Cutter $\phi 3/4"$ ($\phi 19\text{mm}$)



F-1125
Flanged 1.125 in OD
Cutter $\phi 3/4"$ ($\phi 19\text{mm}$)



C
Close Quarters
Cutter $\phi 3/8"$ ($\phi 10\text{mm}$)



F2L
Flanged 2-Leg
Cutter $\phi 3/4"$ ($\phi 19\text{mm}$)



S2L
2-Leg
Cutter $\phi 3/4"$ ($\phi 19\text{mm}$)



S3L
3-Leg
Cutter $\phi 3/4"$ ($\phi 19\text{mm}$)

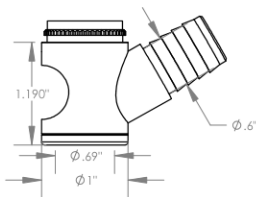

WVI
Vacuum Internal Thread*
Cutter $\phi 5/8"$ ($\phi 15\text{mm}$)

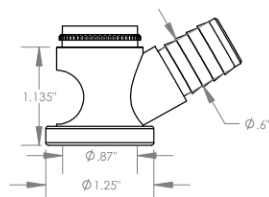

WVE
Vacuum External Thread*
Cutter $\phi 3/4"$ ($\phi 19\text{mm}$)

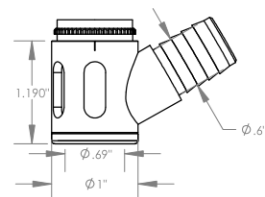

SVI
Slotted Vacuum Internal Thread*
Cutter $\phi 5/8"$ ($\phi 15\text{mm}$)

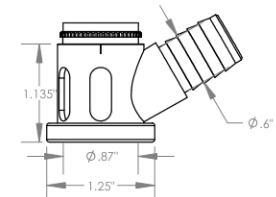

SVE
Slotted Vacuum External Thread*
Cutter $\phi 3/4"$ ($\phi 19\text{mm}$)



WVS
Vacuum Straight
Cutter $\phi 3/4"$ ($\phi 19\text{mm}$)



SVS
Slotted Vacuum Straight
Cutter $\phi 3/4"$ ($\phi 19\text{mm}$)

*Select foot style from table

Revision 09

Do not modify, copy, distribute, or reproduce this drawing without prior written authorization.

All dimensions are in inches



© 2025 Wescon Industries Inc.
601 Century Plaza Dr. Houston, TX 77073, US
www.wesconusa.com

Part Number

WES596

Wescon 596 Microstop

Information in this drawing is provided for reference only

Image 3

Skirt Option



VS
Vacuum Straight
Cutter $\phi 3/4"$ ($\phi 19\text{mm}$)



VE
Vacuum External Thread*
Cutter $\phi 3/4"$ ($\phi 19\text{mm}$)

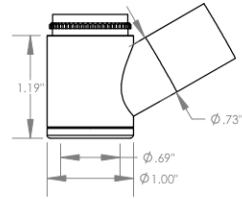

VI
Vacuum Internal Thread*
Cutter $\phi 5/8"$ ($\phi 15\text{mm}$)



Part Number	Material
59631-N	Nylon
59631-S	Steel
59631-P	Phenolic

Foot Style For External Thread



Part Number	Material
59620-N	Nylon
59620-S	Steel
59620-P	Phenolic

Foot Style For Internal Thread



Part Number	Material
59641-N	Nylon
59641-S	Steel
59641-P	Phenolic

Foot Style For Bell External Thread



Part Number	Material
59640-N	Nylon
59640-S	Steel
59640-P	Phenolic

Foot Style For Bell Internal Thread

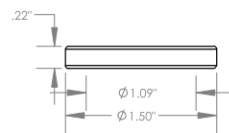

Part Number	Material
59651-N	Nylon
59651-S	Steel
59651-P	Phenolic

Foot Style For Bell Wide External Thread

*Select foot style from table

Revision 09

Do not modify, copy, distribute, or reproduce this drawing without prior written authorization.

All dimensions are in inches



© 2025 Wescon Industries Inc.
601 Century Plaza Dr. Houston, TX 77073, US
www.wesconusa.com

Part Number

WES596

Wescon 596 Microstop

Image 4