

DATASHEET

PART NUMBER

WES597-6-SBWEP

**Wescon 597 Stainless Steel Microstop - M6x1 -
 25.4 mm Cutter Capacity - Slotted Bell Wide
 External Thread Skirt - Phenolic Foot**

HIGH SPEED HEAVY DUTY STAINLESS STEEL

WEBSITE

<https://www.wesconusa.com/products/WES597-6-SBWEP>

* The image represents the general look of the series. Actual product may vary based on options selected.

SPECIFICATIONS

Measurement Type	Metric
Bearing Rating	10,000 rpm
Bearing Type	Dual Ball Bearings
Heavy Duty Thrust Bearing	Yes
Incremental Adjustment	0.013 mm
Shaft Travel	7.60 mm
Dust Seal	Integrated Dust Seal
Cutter Thread	M6x1
Shaft	Round
Shaft Diameter	6.35 mm
Cutter Capacity	25.4 mm
Skirt	Slotted Bell Wide External Thread
Skirt Description	25.4 mm Cutter Capacity
Foot	Phenolic
Solid Stop	Yes
Material	Stainless Steel
Country of Origin	USA

ADDITIONAL IMAGES AND DRAWINGS

WES597 Series Microstop



Part Number
WES597-X-XX-XX

- Shaft Option
- Foot Style
- Skirt Option*
- Cutter Thread

Code	Cutter Thread
(Blank)	1/4-28
6	M6x1
8	M8x1

Code	Foot Style
N	Nylon
S	Steel
P	Phenolic

Code	Shaft Option
(Blank)	1/4in Standard Round
QC	Quick Change
TF	Tri Flat
TSL	1/4-28in Threaded Shank Long

Incremental Adjustment: 0.0005 in
Shaft Travel: 0.300 in
Material: Stainless Steel

Bearing Rating: 10,000 rpm
Bearing Type: Dual Ball-Bearings
Dust Seal: Integrated Dust Seal
Heavy Duty Thrust Bearing: Yes
Solid Stop: Yes

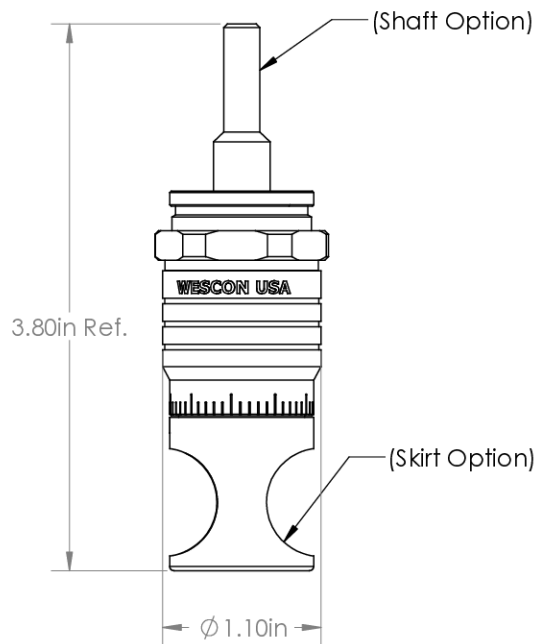

*For Skirt options see next page and website.



Part Number **WES597**

Do not modify, copy, distribute, or reproduce this drawing without prior written authorization.
© 2025 Wescon Industries Inc.
601 Century Plaza Dr. Houston, TX 77073, US
www.wesconusa.com

Wescon 597 Microstop

Revision 03 All dimensions are in inches Information in this drawing is provided for reference only

Image 1

Skirt Option



Continued In Next Page.

Revision 03

Do not modify, copy, distribute, or reproduce this drawing without prior written authorization.

© 2025 Wescon Industries Inc.
601 Century Plaza Dr. Houston, TX 77073, US
www.wesconusa.com

Information in this drawing is provided for reference only



Part Number

WES597

Wescon 597 Microstop

Image 2

Skirt Option (Continuation)



F
Flanged
Cutter $\phi 3/4"$ ($\phi 19$ mm)



FH
Flanged High
Cutter $\phi 3/4"$ ($\phi 19$ mm)



SF
Spherical Flanged
Cutter $\phi 3/4"$ ($\phi 19$ mm)



F-1125
Flanged 1.125 in OD
Cutter $\phi 3/4"$ ($\phi 19$ mm)



C
Close Quarters
Cutter $\phi 3/8"$ ($\phi 10$ mm)



F2L
Flanged 2-Leg
Cutter $\phi 3/4"$ ($\phi 19$ mm)

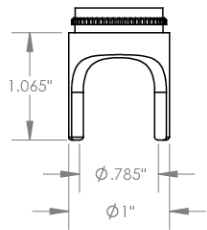

S2L
2-Leg
Cutter $\phi 3/4"$ ($\phi 19$ mm)

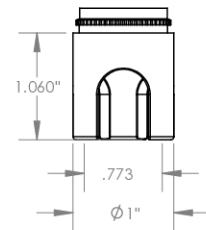

S3L
3-Leg
Cutter $\phi 3/4"$ ($\phi 19$ mm)

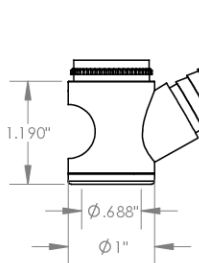

VI
Vacuum Internal Thread
Cutter $\phi 5/8"$ ($\phi 15$ mm)

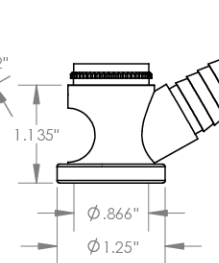

VE
Vacuum External Thread
Cutter $\phi 3/4"$ ($\phi 19$ mm)

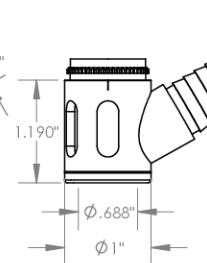

SVI
Slotted Vacuum External Thread
Cutter $\phi 5/8"$ ($\phi 15$ mm)

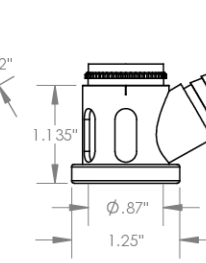

SVE
Slotted Vacuum External Thread
Cutter $\phi 3/4"$ ($\phi 19$ mm)



Part Number

WES597

Do not modify, copy, distribute, or reproduce this drawing without prior written authorization.

© 2025 Wescon Industries Inc.
601 Century Plaza Dr. Houston, TX 77073, US
www.wesconusa.com

Wescon 597 Microstop

Revision 03

All dimensions are in inches

Information in this drawing is provided for reference only

Image 3

**Foot Style
For External Thread**



Part Number	Material
59631-N	Nylon
59631-S	Steel
59631-P	Phenolic

**Foot Style
For Internal Thread**



Part Number	Material
59620-N	Nylon
59620-S	Steel
59620-P	Phenolic

**Foot Style
For Bell External Thread**



Part Number	Material
59641-N	Nylon
59641-S	Steel
59641-P	Phenolic

**Foot Style
For Bell Internal Thread**



Part Number	Material
59640-N	Nylon
59640-S	Steel
59640-P	Phenolic

**Foot Style
For Bell Wide External Thread**



Part Number	Material
59651-N	Nylon
59651-S	Steel
59651-P	Phenolic

		Part Number	WES597
Do not modify, copy, distribute, or reproduce this drawing without prior written authorization.		Wescon 597 Microstop	
Revision 03	All dimensions are in inches © 2025 Wescon Industries Inc. 601 Century Plaza Dr. Houston, TX 77073, US www.wesconusa.com Information in this drawing is provided for reference only		

Image 4