

## DATASHEET

PART NUMBER

# WES597-SVS

**Wescon 597 Stainless Steel Microstop - 1/4-28  
- 3/4" Cutter Capacity - Slotted Vacuum  
Straight Skirt**

HIGH SPEED HEAVY DUTY STAINLESS STEEL

WEBSITE

<https://www.wesconusa.com/products/WES597-SVS>



\* The image represents the general look of the series. Actual product may vary based on options selected.

## SPECIFICATIONS

<b>Measurement Type</b>	Imperial
<b>Bearing Rating</b>	10,000 rpm
<b>Bearing Type</b>	Dual Ball Bearings
<b>Heavy Duty Thrust Bearing</b>	Yes
<b>Incremental Adjustment</b>	0.0005 in
<b>Shaft Travel</b>	0.300 in
<b>Dust Seal</b>	Integrated Dust Seal
<b>Cutter Thread</b>	1/4-28
<b>Shaft</b>	Round
<b>Shaft Diameter</b>	1/4 in
<b>Cutter Capacity</b>	3/4 in
<b>Skirt</b>	Slotted Vacuum Straight
<b>Skirt Description</b>	1 in OD 0.87 in ID 3/4 in Cutter Capacity
<b>Solid Stop</b>	Yes
<b>Material</b>	Stainless Steel
<b>Vacuum Adapter</b>	Yes
<b>Country of Origin</b>	USA

**ADDITIONAL IMAGES AND DRAWINGS**

**WES597 Series Microstop**



**Part Number**  
WES597-X-XX-XX

- └─ Shaft Option
- └─ Foot Style
- └─ Skirt Option\*
- └─ Cutter Thread

Code	Cutter Thread
(Blank)	1/4-28
6	M6x1
8	M8x1

Code	Foot Style
N	Nylon
S	Steel
P	Phenolic

Code	Shaft Option
(Blank)	1/4in Standard Round
QC	Quick Change
TF	Tri Flat
TSL	1/4-28in Threaded Shank Long

Incremental Adjustment: 0.0005 in  
Shaft Travel: 0.300 in  
Material: Stainless Steel

Bearing Rating: 10,000 rpm  
Bearing Type: Dual Ball-Bearings  
Dust Seal: Integrated Dust Seal  
Heavy Duty Thrust Bearing: Yes  
Solid Stop: Yes

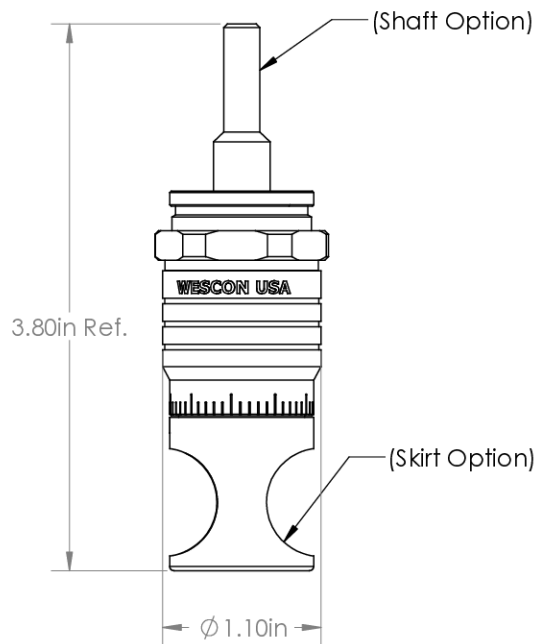

\*For Skirt options see next page and website.



Part Number **WES597**

Do not modify, copy, distribute, or reproduce this drawing without prior written authorization.  
© 2025 Wescon Industries Inc.  
601 Century Plaza Dr. Houston, TX 77073, US  
www.wesconusa.com

Wescon 597 Microstop

Revision 04 All dimensions are in inches Information in this drawing is provided for reference only

Image 1

### Skirt Option



Continued In Next Page.

Revision 04

Do not modify, copy, distribute, or reproduce this drawing without prior written authorization.

© 2025 Wescon Industries Inc.  
601 Century Plaza Dr. Houston, TX 77073, US  
www.wesconusa.com

Information in this drawing is provided for reference only



Part Number

**WES597**

Wescon 597 Microstop

### Skirt Option (Continuation)



**F**  
Flanged  
Cutter  $\phi 3/4"$  ( $\phi 19\text{mm}$ )

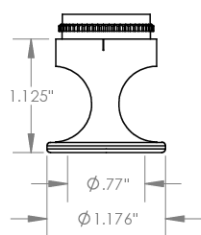

**FH**  
Flanged High  
Cutter  $\phi 3/4"$  ( $\phi 19\text{mm}$ )



**SF**  
Spherical Flanged  
Cutter  $\phi 3/4"$  ( $\phi 19\text{mm}$ )



**F-1125**  
Flanged 1.125 in OD  
Cutter  $\phi 3/4"$  ( $\phi 19\text{mm}$ )



**C**  
Close Quarters  
Cutter  $\phi 3/8"$  ( $\phi 10\text{mm}$ )

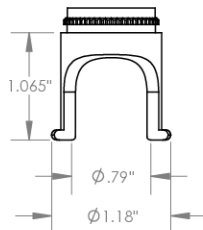

**F2L**  
Flanged 2-Leg  
Cutter  $\phi 3/4"$  ( $\phi 19\text{mm}$ )

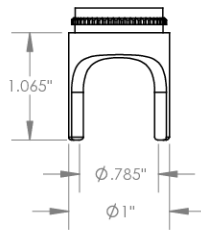

**S2L**  
2-Leg  
Cutter  $\phi 3/4"$  ( $\phi 19\text{mm}$ )

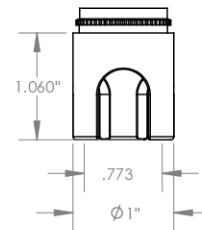

**S3L**  
3-Leg  
Cutter  $\phi 3/4"$  ( $\phi 19\text{mm}$ )



**WVI**  
Vacuum Internal Thread  
Cutter  $\phi 5/8"$  ( $\phi 15\text{mm}$ )

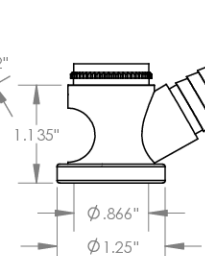

**WVE**  
Vacuum External Thread  
Cutter  $\phi 3/4"$  ( $\phi 19\text{mm}$ )

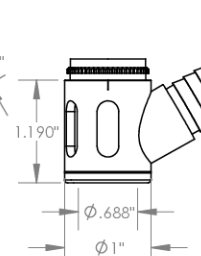

**SVI**  
Slotted Vacuum External Thread  
Cutter  $\phi 5/8"$  ( $\phi 15\text{mm}$ )

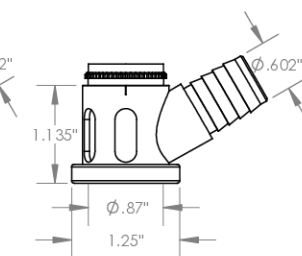

**SVE**  
Slotted Vacuum External Thread  
Cutter  $\phi 3/4"$  ( $\phi 19\text{mm}$ )



Part Number

**WES597**

Do not modify, copy, distribute, or reproduce this drawing without prior written authorization.

© 2025 Wescon Industries Inc.  
601 Century Plaza Dr. Houston, TX 77073, US  
www.wesconusa.com

Wescon 597 Microstop

Revision 04

All dimensions are in inches

Information in this drawing is provided for reference only

Image 3

**Foot Style  
For External Thread**



Part Number	Material
59631-N	Nylon
59631-S	Steel
59631-P	Phenolic

**Foot Style  
For Internal Thread**



Part Number	Material
59620-N	Nylon
59620-S	Steel
59620-P	Phenolic

**Foot Style  
For Bell External Thread**



Part Number	Material
59641-N	Nylon
59641-S	Steel
59641-P	Phenolic

**Foot Style  
For Bell Internal Thread**

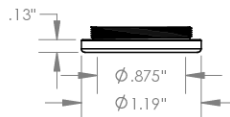

Part Number	Material
59640-N	Nylon
59640-S	Steel
59640-P	Phenolic

**Foot Style  
For Bell Wide External Thread**



Part Number	Material
59651-N	Nylon
59651-S	Steel
59651-P	Phenolic



Part Number **WES597**

Do not modify, copy, distribute, or reproduce this drawing without prior written authorization.

© 2025 Wescon Industries Inc.  
601 Century Plaza Dr. Houston, TX 77073, US  
www.wesconusa.com

Wescon 597 Microstop

Revision 04 All dimensions are in inches Information in this drawing is provided for reference only

Image 4