

## DATASHEET

PART NUMBER

# WES598-8-S-QC

**Wescon 598 Microstop - M8x1 - 19 mm Cutter Capacity - Straight**

10 DEGREE PIVOTING SHAFT (SWIVEL SHAFT) / HIGH SPEED HEAVY DUTY

WEBSITE

<https://www.wesconusa.com/products/WES598-8-S-QC>



\* The image represents the general look of the series. Actual product may vary based on options selected.

## SPECIFICATIONS

|                           |  |
|---------------------------|--|
| Measurement Type          | Metric                                 |
| Bearing Rating            | 10,000 rpm                             |
| Bearing Type              | Dual Ball Bearings                     |
| Heavy Duty Thrust Bearing | Yes                                    |
| Incremental Adjustment    | 0.013 mm                               |
| Shaft Travel              | 7.60 mm                                |
| Dust Seal                 | Integrated Dust Seal                   |
| Cutter Thread             | M8x1                                   |
| Shaft                     | Quick Change - Pivoting / Swivel Shaft |
| Shaft Diameter            | 6.35 mm                                |
| Cutter Capacity           | 19 mm                                  |
| Skirt                     | Straight                               |
| Skirt Description         | 25.4 mm OD 19 mm Cutter Capacity       |
| Solid Stop                | Yes                                    |
| Material                  | Steel                                  |
| Country of Origin         | USA                                    |

## ADDITIONAL IMAGES AND DRAWINGS

### WES598 Series Microstop



**Part Number**  
WES598-X-XX-XX



Incremental Adjustment: 0.0005 in  
Shaft Travel: 0.300 in  
Material: Carbon Steel Body with  
Hardened Tool Steel Shaft

Bearing Rating: 10,000 rpm  
Bearing Type: Dual Ball-Bearings  
Dust Seal: Integrated Dust Seal  
Heavy Duty Thrust Bearing: Yes  
Solid Stop: Yes

| Code    | Cutter Thread |
|---------|---------------|
| (Blank) | 1/4-28        |
| 6       | M6x1          |
| 8       | M8x1          |

| Code | Foot Style |
|------|------------|
| N    | Nylon      |
| S    | Steel      |
| P    | Phenolic   |

| Code    | Shaft Option              |
|---------|---------------------------|
| (Blank) | Round Swivel Shaft        |
| QC      | Quick Change Swivel Shaft |
| TF      | Tri Flat Swivel Shaft     |

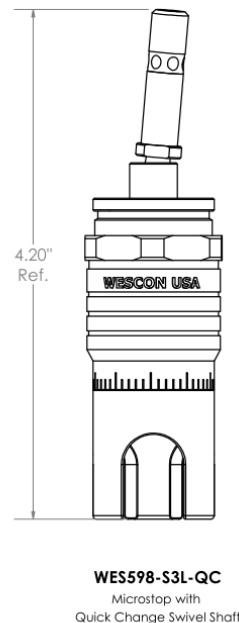
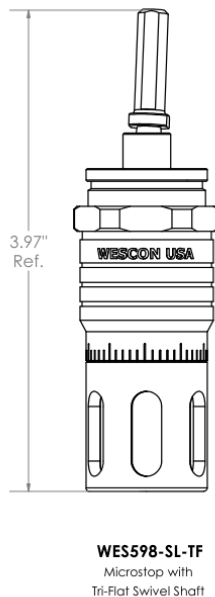
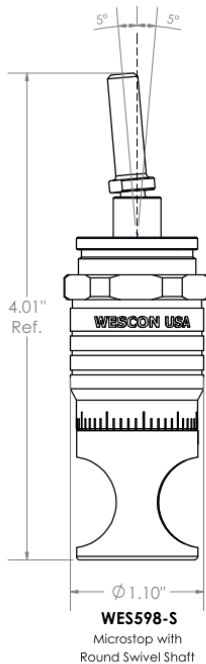

\*For Skirt options see next page and website.



Part Number

**WES598**

Do not modify, copy, distribute, or reproduce this drawing without prior written authorization.

© 2025 Wescon Industries Inc.  
601 Century Plaza Dr. Houston, TX 77073, US  
www.wesconusa.com

Wescon 598 Microstop

Revision 09

All dimensions are in Inches

Information in this drawing is provided for reference only

Image 1

### Skirt Option



**S**  
Straight  
Cutter  $\phi 3/4"$  ( $\phi 19\text{mm}$ )



**I**  
Internal Thread\*  
Cutter  $\phi 5/8"$  ( $\phi 15\text{mm}$ )



**E**  
External Thread\*  
Cutter  $\phi 3/4"$  ( $\phi 19\text{mm}$ )



**SCA**  
Straight Cutaway  
Cutter  $\phi 3/4"$  ( $\phi 19\text{mm}$ )



**SL**  
Slotted  
Cutter  $\phi 3/4"$  ( $\phi 19\text{mm}$ )



**SI**  
Slotted Internal Thread\*  
Cutter  $\phi 5/8"$  ( $\phi 15\text{mm}$ )



**SE**  
Slotted External Thread\*  
Cutter  $\phi 3/4"$  ( $\phi 19\text{mm}$ )



**SSCA**  
Slotted Straight Cutaway  
Cutter  $\phi 3/4"$  ( $\phi 19\text{mm}$ )



**B**  
Bell  
Cutter  $\phi 7/8"$  ( $\phi 22\text{mm}$ )



**BI**  
Bell Internal Thread\*  
Cutter  $\phi 3/4"$  ( $\phi 19\text{mm}$ )



**BE**  
Bell External Thread\*  
Cutter  $\phi 7/8"$  ( $\phi 22\text{mm}$ )



**FCA**  
Flanged Cutaway  
Cutter  $\phi 3/4"$  ( $\phi 19\text{mm}$ )



**SBI**  
Slotted Bell Internal Thread\*  
Cutter  $\phi 3/4"$  ( $\phi 19\text{mm}$ )



**SBE**  
Slotted Bell External Thread\*  
Cutter  $\phi 7/8"$  ( $\phi 22\text{mm}$ )



**BWE**  
Bell Wide External Thread\*  
Cutter  $\phi 1"$  ( $\phi 25\text{mm}$ )



**S-875**  
Straight 0.875 in OD  
Cutter  $\phi 5/8"$  ( $\phi 15\text{mm}$ )

\*Select foot style from table  
Continued In Next Page.

Do not modify, copy, distribute, or reproduce this drawing without prior written authorization.



Part Number

**WES598**

© 2025 Wescon Industries Inc.  
601 Century Plaza Dr. Houston, TX 77073, US  
www.wesconusa.com

Wescon 598 Microstop

Revision 09

All dimensions are in Inches

Information in this drawing is provided for reference only

Image 2

### Skirt Option (Continuation)



**F**  
Flanged  
Cutter  $\phi 3/4"$  ( $\phi 19\text{mm}$ )



**FH**  
Flanged High  
Cutter  $\phi 3/4"$  ( $\phi 19\text{mm}$ )



**SF**  
Spherical Flanged  
Cutter  $\phi 3/4"$  ( $\phi 19\text{mm}$ )



**F-1125**  
Flanged 1.125 in OD  
Cutter  $\phi 3/4"$  ( $\phi 19\text{mm}$ )



**C**  
Close Quarters  
Cutter  $\phi 3/8"$  ( $\phi 10\text{mm}$ )



**F2L**  
Flanged 2-Leg  
Cutter  $\phi 3/4"$  ( $\phi 19\text{mm}$ )



**S2L**  
2-Leg  
Cutter  $\phi 3/4"$  ( $\phi 19\text{mm}$ )



**S3L**  
3-Leg  
Cutter  $\phi 3/4"$  ( $\phi 19\text{mm}$ )



**WVI**  
Vacuum Internal Thread\*  
Cutter  $\phi 5/8"$  ( $\phi 15\text{mm}$ )



**WVE**  
Vacuum External Thread\*  
Cutter  $\phi 3/4"$  ( $\phi 19\text{mm}$ )



**SVI**  
Slotted Vacuum Internal Thread\*  
Cutter  $\phi 5/8"$  ( $\phi 15\text{mm}$ )



**SVE**  
Slotted Vacuum External Thread\*  
Cutter  $\phi 3/4"$  ( $\phi 19\text{mm}$ )



**WVS**  
Vacuum Straight  
Cutter  $\phi 3/4"$  ( $\phi 19\text{mm}$ )

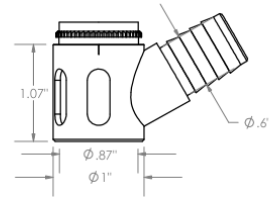

**SVS**  
Slotted Vacuum Straight  
Cutter  $\phi 3/4"$  ( $\phi 19\text{mm}$ )

\*Select foot style from table

|             |                              |  |   |
|-------------|------------------------------|--|---|
| Revision 09 | All dimensions are in Inches | <br>© 2025 Wescon Industries Inc.<br>601 Century Plaza Dr. Houston, TX 77073, US<br>www.wesconusa.com | Part Number                               |
|             |                              |  | <b>WES598</b><br><br>Wescon 598 Microstop |

Image 3

### Skirt Option



**VS**  
Vacuum Straight  
Cutter  $\Phi 3/4"$  ( $\Phi 19\text{mm}$ )



**VE**  
Vacuum External Thread\*  
Cutter  $\Phi 3/4"$  ( $\Phi 19\text{mm}$ )



**VI**  
Vacuum Internal Thread\*  
Cutter  $\Phi 5/8"$  ( $\Phi 15\text{mm}$ )



**Foot Style For External Thread**

| Part Number | Material |
|-------------|----------|
| 59631-N     | Nylon    |
| 59631-S     | Steel    |
| 59631-P     | Phenolic |



**Foot Style For Internal Thread**

| Part Number | Material |
|-------------|----------|
| 59620-N     | Nylon    |
| 59620-S     | Steel    |
| 59620-P     | Phenolic |



**Foot Style For Bell External Thread**

| Part Number | Material |
|-------------|----------|
| 59641-N     | Nylon    |
| 59641-S     | Steel    |
| 59641-P     | Phenolic |



**Foot Style For Bell Internal Thread**

| Part Number | Material |
|-------------|----------|
| 59640-N     | Nylon    |
| 59640-S     | Steel    |
| 59640-P     | Phenolic |



**Foot Style For Bell Wide External Thread**

| Part Number | Material |
|-------------|----------|
| 59651-N     | Nylon    |
| 59651-S     | Steel    |
| 59651-P     | Phenolic |

\*Select foot style from table

Revision 09

Do not modify, copy, distribute, or reproduce this drawing without prior written authorization.

All dimensions are in Inches



© 2025 Wescon Industries Inc.  
601 Century Plaza Dr. Houston, TX 77073, US  
www.wesconusa.com

Information in this drawing is provided for reference only

Part Number

**WES598**

Wescon 598 Microstop

Image 4