

## DATASHEET

PART NUMBER

### WES599-6-SBIP-TF

**Wescon 599 Stainless Steel Microstop - M6x1 - 19 mm Cutter Capacity - Slotted Bell Skirt Internal Phenolic Foot**

10 DEGREE PIVOTING SHAFT (SWIVEL SHAFT) / HIGH SPEED HEAVY DUTY STAINLESS STEEL

WEBSITE

<https://www.wesconusa.com/products/WES599-6-SBIP-TF>



\* The image represents the general look of the series. Actual product may vary based on options selected.

## SPECIFICATIONS

Measurement Type	Metric
Bearing Rating	10,000 rpm
Bearing Type	Dual Ball Bearings
Heavy Duty Thrust Bearing	Yes
Incremental Adjustment	0.013 mm
Shaft Travel	7.60 mm
Dust Seal	Integrated Dust Seal
Cutter Thread	M6x1
Shaft	Tri-Flat - Pivoting / Swivel Shaft
Shaft Diameter	6.35 mm
Cutter Capacity	19 mm
Skirt	Slotted Bell Internal Thread
Skirt Description	30 mm OD 19 mm Cutter Capacity
Foot	Phenolic
Solid Stop	Yes
Material	Stainless Steel
Country of Origin	USA

# ADDITIONAL IMAGES AND DRAWINGS

## WES599 Series Microstop



**Part Number**  
WES599-X-XX-XX

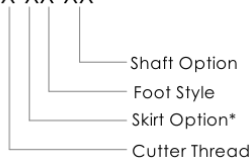

Incremental Adjustment: 0.0005 in  
Shaft Travel: 0.300 in  
Material: Carbon Steel Body with  
Hardened Tool Steel Shaft

Bearing Rating: 10,000 rpm  
Bearing Type: Dual Ball-Bearings  
Dust Seal: Integrated Dust Seal  
Heavy Duty Thrust Bearing: Yes  
Solid Stop: Yes

Code	Cutter Thread
(Blank)	1/4-28
6	M6x1
8	M8x1

Code	Foot Style
N	Nylon
S	Steel
P	Phenolic

Code	Shaft Option
(Blank)	Round Swivel Shaft
QC	Quick Change Swivel Shaft
TF	Tri Flat Swivel Shaft



\*For Skirt options see next page and website.



Part Number

**WES599**

Do not modify, copy, distribute, or reproduce this drawing without prior written authorization.

© 2025 Wescon Industries Inc.  
601 Century Plaza Dr. Houston, TX 77073, US  
www.wesconusa.com

Wescon 599 Microstop

Revision 07

All dimensions are in Inches

Information in this drawing is provided for reference only

Image 1

### Skirt Option



**S**  
Straight  
Cutter  $\phi 3/4"$  ( $\phi 19\text{mm}$ )



**I**  
Internal Thread\*  
Cutter  $\phi 5/8"$  ( $\phi 15\text{mm}$ )



**E**  
External Thread\*  
Cutter  $\phi 3/4"$  ( $\phi 19\text{mm}$ )



**SCA**  
Straight Cutaway  
Cutter  $\phi 3/4"$  ( $\phi 19\text{mm}$ )



**SL**  
Slotted  
Cutter  $\phi 3/4"$  ( $\phi 19\text{mm}$ )



**SI**  
Slotted Internal Thread\*  
Cutter  $\phi 5/8"$  ( $\phi 15\text{mm}$ )



**SE**  
Slotted External Thread\*  
Cutter  $\phi 3/4"$  ( $\phi 19\text{mm}$ )



**SSCA**  
Slotted Straight Cutaway  
Cutter  $\phi 3/4"$  ( $\phi 19\text{mm}$ )



**B**  
Bell  
Cutter  $\phi 7/8"$  ( $\phi 22\text{mm}$ )



**BI**  
Bell Internal Thread\*  
Cutter  $\phi 3/4"$  ( $\phi 19\text{mm}$ )



**BE**  
Bell External Thread\*  
Cutter  $\phi 7/8"$  ( $\phi 22\text{mm}$ )



**FCA**  
Flanged Cutaway  
Cutter  $\phi 3/4"$  ( $\phi 19\text{mm}$ )



**SBI**  
Slotted Bell Internal Thread\*  
Cutter  $\phi 3/4"$  ( $\phi 19\text{mm}$ )



**SBE**  
Slotted Bell External Thread\*  
Cutter  $\phi 7/8"$  ( $\phi 22\text{mm}$ )



**BWE**  
Bell Wide External Thread\*  
Cutter  $\phi 1"$  ( $\phi 25\text{mm}$ )



**S-875**  
Straight 0.875 in OD  
Cutter  $\phi 5/8"$  ( $\phi 15\text{mm}$ )

\*Select foot style from table  
Continued In Next Page.

Do not modify, copy, distribute, or reproduce this drawing without prior written authorization.



Part Number

**WES599**

© 2025 Wescon Industries Inc.  
601 Century Plaza Dr. Houston, TX 77073, US  
www.wesconusa.com

Wescon 599 Microstop

Revision 07

All dimensions are in Inches

Information in this drawing is provided for reference only

Image 2

### Skirt Option (Continuation)



**F**  
Flanged  
Cutter  $\phi 3/4"$  ( $\phi 19\text{mm}$ )



**FH**  
Flanged High  
Cutter  $\phi 3/4"$  ( $\phi 19\text{mm}$ )



**SF**  
Spherical Flanged  
Cutter  $\phi 3/4"$  ( $\phi 19\text{mm}$ )



**F-1125**  
Flanged 1.125 in OD  
Cutter  $\phi 3/4"$  ( $\phi 19\text{mm}$ )



**C**  
Close Quarters  
Cutter  $\phi 3/8"$  ( $\phi 10\text{mm}$ )



**F2L**  
Flanged 2-Leg  
Cutter  $\phi 3/4"$  ( $\phi 19\text{mm}$ )



**S2L**  
2-Leg  
Cutter  $\phi 3/4"$  ( $\phi 19\text{mm}$ )



**S3L**  
3-Leg  
Cutter  $\phi 3/4"$  ( $\phi 19\text{mm}$ )



**WVI**  
Vacuum Internal Thread\*  
Cutter  $\phi 5/8"$  ( $\phi 15\text{mm}$ )



**WVE**  
Vacuum External Thread\*  
Cutter  $\phi 3/4"$  ( $\phi 19\text{mm}$ )



**SVI**  
Slotted Vacuum Internal Thread\*  
Cutter  $\phi 5/8"$  ( $\phi 15\text{mm}$ )



**SVE**  
Slotted Vacuum External Thread\*  
Cutter  $\phi 3/4"$  ( $\phi 19\text{mm}$ )



**WVS**  
Vacuum Straight  
Cutter  $\phi 3/4"$  ( $\phi 19\text{mm}$ )



**SVS**  
Slotted Vacuum Straight  
Cutter  $\phi 3/4"$  ( $\phi 19\text{mm}$ )

\*Select foot style from table

			Part Number	<b>WES599</b>
	Do not modify, copy, distribute, or reproduce this drawing without prior written authorization.	© 2025 Wescon Industries Inc. 601 Century Plaza Dr. Houston, TX 77073, US www.wesconusa.com		Wescon 599 Microstop
Revision 07	All dimensions are in Inches	Information in this drawing is provided for reference only		

Image 3

### Skirt Option



**VS**  
Vacuum Straight  
Cutter  $\phi 3/4"$  ( $\phi 19\text{mm}$ )



**VE**  
Vacuum External Thread\*  
Cutter  $\phi 3/4"$  ( $\phi 19\text{mm}$ )



**VI**  
Vacuum Internal Thread\*  
Cutter  $\phi 5/8"$  ( $\phi 15\text{mm}$ )



**Foot Style For External Thread**

Part Number	Material
59631-N	Nylon
59631-S	Steel
59631-P	Phenolic



**Foot Style For Internal Thread**

Part Number	Material
59620-N	Nylon
59620-S	Steel
59620-P	Phenolic



**Foot Style For Bell External Thread**

Part Number	Material
59641-N	Nylon
59641-S	Steel
59641-P	Phenolic



**Foot Style For Bell Internal Thread**

Part Number	Material
59640-N	Nylon
59640-S	Steel
59640-P	Phenolic



**Foot Style For Bell Wide External Thread**

Part Number	Material
59651-N	Nylon
59651-S	Steel
59651-P	Phenolic

\*Select foot style from table

Revision 07

Do not modify, copy, distribute, or reproduce this drawing without prior written authorization.

All dimensions are in Inches



© 2025 Wescon Industries Inc.  
601 Century Plaza Dr. Houston, TX 77073, US  
www.wesconusa.com

Information in this drawing is provided for reference only

Part Number

**WES599**

**Wescon 599 Microstop**

Image 4