

DATASHEET

PART NUMBER

WES690-10-1375-TF

**Wescon 690 Microstop - M10x1 - 35 mm Cutter
Capacity - Straight**

LARGE CAPACITY UNITS

WEBSITE

<https://www.wesconusa.com/products/WES690-10-1375-TF>



* The image represents the general look of the series. Actual product may vary based on options selected.

SPECIFICATIONS

Measurement Type	Metric
Bearing Rating	3,000 rpm
Bearing Type	Bronze Bearing
Heavy Duty Thrust Bearing	Yes
Incremental Adjustment	0.013 mm
Shaft Travel	12.70 mm
Dust Seal	No
Cutter Thread	M10x1
Shaft	Tri-Flat
Shaft Diameter	9.525 mm
Cutter Capacity	35 mm
Skirt	Straight
Solid Stop	No
Material	Steel
Country of Origin	USA

ADDITIONAL IMAGES AND DRAWINGS

WES690 Series Microstop



Part Number
WES690-XX-XX-XX-XX



Incremental Adjustment: 0.0005 in
Shaft Travel: 0.500 in
Material: Carbon Steel Body with
Hardened Tool Steel Shaft

Bearing Rating: 3,000 rpm
Bearing Type: Bronze Bearing
Heavy Duty Thrust Bearing: Yes
Solid Stop: Yes

Code	Shaft Thread
(Blank)	3/8-24
4320	7/16-20
8	M8x1
10	M10x1

Code	Foot Style
N	Nylon
S	Steel

Code	Shaft Option
TF	Tri Flat

Code	Cutter Capacity	Ø A	OD for S, SCA, S2L & S3L		OD for E & SE	
			Ø B	Ø C	Ø C	Ø C
875	7/8"(22 mm)	1" (25.4 mm)	1-3/16" (30 mm)	1.40 (36 mm)		
1000	1"(25 mm)	1-1/8" (29 mm)	1-3/8" (35 mm)	1.56 (40 mm)		
1250	1-1/4"(32 mm)	1-3/8" (35 mm)	1-5/8" (42 mm)	1.81 (46 mm)		
1375	1-3/8"(35 mm)	1-1/2" (38 mm)	1-7/8" (48 mm)	2.13 (54 mm)		
1500	1-1/2"(38 mm)	1-5/8" (42 mm)	2" (50.8 mm)	2.25 (57 mm)		
2000	2"(50.8 mm)	2-1/4" (58 mm)	2-1/2" (64 mm)	2.630 (67 mm)		

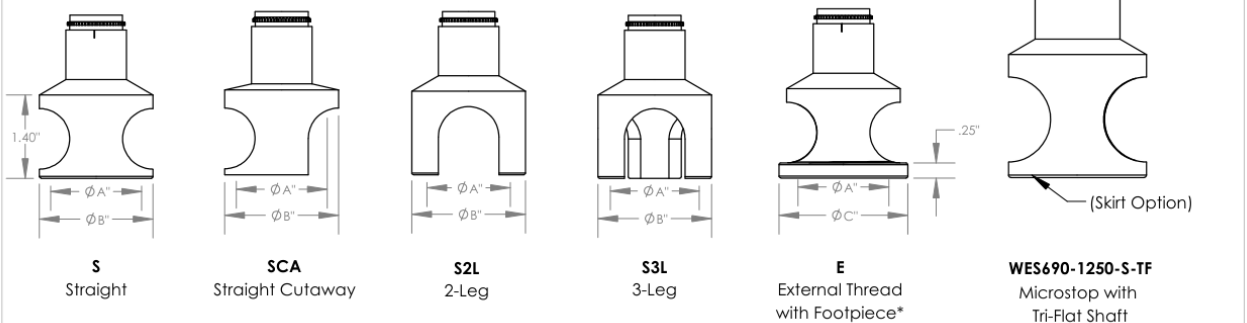

*Select foot style from table



Part Number

WES690

Do not modify, copy, distribute, or reproduce this drawing without prior written authorization.

© 2025 Wescon Industries Inc.
601 Century Plaza Dr. Houston, TX 77073, US
www.wesconusa.com

Wescon 690 Microstop

Revision 04

All dimensions are in Inches Information in this drawing is provided for reference only

Image 1