

DATASHEET

PART NUMBER

WES690-8-875-ES-TF

**Wescon 690 Microstop - M8x1 - 22 mm Cutter
Capacity - External Steel Foot**

LARGE CAPACITY UNITS

WEBSITE

<https://www.wesconusa.com/products/WES690-8-875-ES-TF>



* The image represents the general look of the series. Actual product may vary based on options selected.

SPECIFICATIONS

Measurement Type	Metric
Bearing Rating	3,000 rpm
Bearing Type	Bronze Bearing
Heavy Duty Thrust Bearing	Yes
Incremental Adjustment	0.013 mm
Shaft Travel	12.70 mm
Dust Seal	No
Cutter Thread	M8x1
Shaft	Tri-Flat
Shaft Diameter	9.525 mm
Cutter Capacity	22 mm
Skirt	External Thread
Foot	Steel
Solid Stop	No
Material	Steel
Country of Origin	USA

ADDITIONAL IMAGES AND DRAWINGS

WES690 Series Microstop



Part Number

WES690-XX-XX-XX-XX



Code	Shaft Thread
(Blank)	3/8-24
4320	7/16-20
8	M8x1
10	M10x1

Code	Cutter Capacity
875	7/8"(22mm)
1000	1"(25mm)
1250	1-1/4"(32mm)
1375	1-3/8"(35mm)
1500	1-1/2"(38mm)
2000	2"(50.8mm)

Code	Foot Style
N	Nylon
S	Steel

Code	Shaft Option
TF	Tri Flat



Incremental Adjustment: 0.0005 in
 Shaft Travel: 0.500 in
 Material: Carbon Steel Body with
 Hardened Tool Steel Shaft

Bearing Rating: 3,000 rpm
 Bearing Type: Bronze Bearing
 Heavy Duty Thrust Bearing: Yes
 Solid Stop: Yes

*For skirt options see next page and website.



Part Number

WES690

Do not modify, copy, distribute, or reproduce this drawing without prior written authorization.

© 2025 Wescon Industries Inc.
 601 Century Plaza Dr. Houston, TX 77073. US
 www.wesconusa.com

Wescon 690 Microstop

Revision 03 All dimensions are in Inches Information in this drawing is provided for reference only

Image 1

Skirt Option

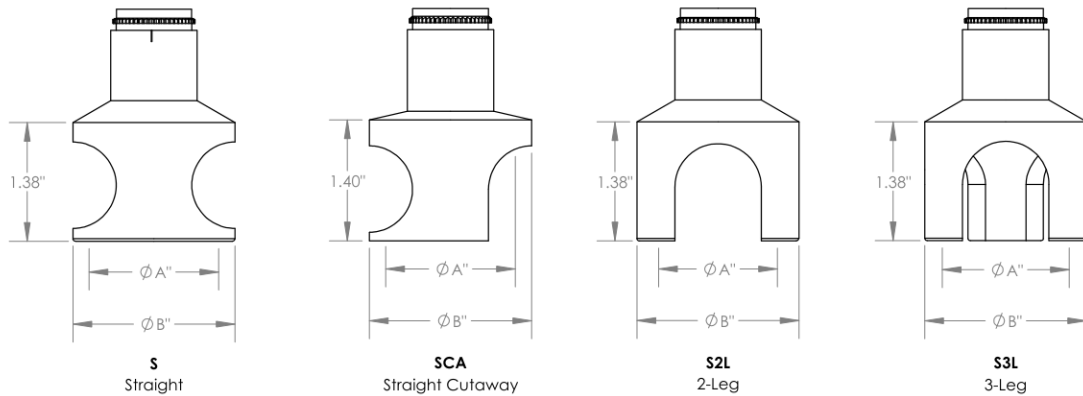

Foot Style For External Thread



E
External Thread
Choose Foot Style From Table



Part Number	Material
59631-N	Nylon
59631-S	Steel
59631-P	Phenolic

Code	Cutter Capacity	ϕA	OD for S,SCA,S2L & S3L		OD for E & SE
			ϕB	ϕC	
875	7/8"(22 mm)	7/8" (22 mm)	1-3/16" (30 mm)	1.317 (33 mm)	
1000	1"(25 mm)	1-5/8" (42 mm)	1-7/8" (48 mm)	1.945 (49 mm)	
1250	1-1/4"(32 mm)	1-1/2" (38 mm)	1-5/8" (42 mm)	1.755 (45 mm)	
1375	1-3/8"(35 mm)	1-5/8" (42 mm)	1-7/8" (48 mm)	2.005 (50.8 mm)	
1500	1-1/2"(38 mm)	1-1/2" (38 mm)	2" (50.8 mm)	2.130 (54 mm)	
2000	2"(50.8 mm)	2-1/4" (58 mm)	2-1/2" (64 mm)	2.630 (67 mm)	



Part Number

WES690

Do not modify, copy, distribute, or reproduce this drawing without prior written authorization.

© 2025 Wescon Industries Inc.
601 Century Plaza Dr. Houston, TX 77073, US
www.wesconusa.com

Wescon 690 Microstop

Revision 03

All dimensions are in inches

Information in this drawing is provided for reference only

Image 2