

DATASHEET

PART NUMBER

WES696-1250-S3L-4320-TF

**Wescon 696 Microstop - 7/16-20 - 1-1/4" Cutter
Capacity - 3-Leg Skirt**

LARGE CAPACITY UNITS FOR STEEL, ALUMINUM &
COMPOSITES

WEBSITE

<https://www.wesconusa.com/products/WES696-1250-S3L-4320-TF>



* The image represents the general look of the series. Actual product may vary based on options selected.

SPECIFICATIONS

Measurement Type	Imperial
Bearing Rating	10,000 rpm
Bearing Type	Dual Ball-Bearings
Heavy Duty Thrust Bearing	Yes
Incremental Adjustment	0.0005 in
Shaft Travel	1/2 in
Dust Seal	Integrated Dust Seal
Cutter Thread	7/16-20
Shaft	Tri-Flat
Shaft Diameter	3/8 in
Cutter Capacity	1-1/4 in
Skirt	3-Leg
Solid Stop	Yes
Material	Steel
Country of Origin	USA

ADDITIONAL IMAGES AND DRAWINGS

WES696 Series Microstop

Part Number

WES696-XX-XX-XX-XX

- Shaft Option
- Foot Style
- Skirt Option*
- Cutter Capacity
- Shaft Thread



Code	Shaft Thread
Blank	3/8-24
4320	7/16-20
8	M8x1
10	M10x1

Code	Cutter Capacity
875	7/8"(22mm)
1000	1"(25mm)
1250	1-1/4"(32mm)
1375	1-3/8"(35mm)
1500	1-1/2"(38mm)
2000	2"(50.8mm)

Code	Foot Style
N	Nylon
S	Steel

Code	Shaft Option
(Blank)	Round
QC	Quick Change
TF	Tri Flat

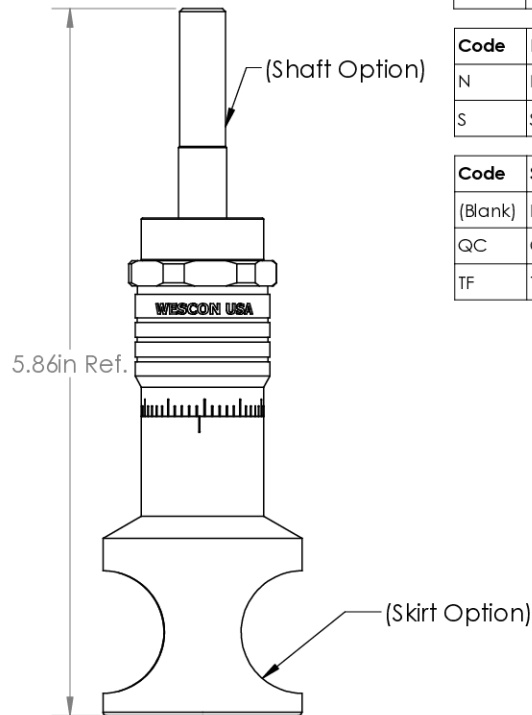

Incremental Adjustment: 0.0005 in
 Shaft Travel: 0.500 in
 Material: Carbon Steel Body with
 Hardened Tool Steel Shaft

Bearing Rating: 10,000 rpm
 Bearing Type: Dual Ball Bearings
 Dust Seal: Integrated Dust Seal
 Heavy Duty Thrust Bearing: Yes
 Solid Stop: Yes

*For skirt options see next page and website.



Part Number

WES696

Do not modify, copy, distribute, or reproduce this drawing without prior written authorization.

© 2025 Wescon Industries Inc.
 601 Century Plaza Dr. Houston, TX 77073, US
 www.wesconusa.com

Wescon 696 Microstop

Revision 02 All dimensions are in inches Information in this drawing is provided for reference only

Image 1

Skirt Option



Foot Style For External Thread



E
External Thread
Choose Foot Style From Table



Part Number	Material
59631-N	Nylon
59631-S	Steel
59361-P	Phenolic

Code	Cutter Capacity	ϕA	OD for S, SCA, S2L & S3L		OD for E & SE
			ϕB	ϕC	
875	7/8" (22 mm)	7/8" (22 mm)	1-3/16" (30 mm)	1.317 (33 mm)	
1000	1" (25 mm)	1-5/8" (42 mm)	1-7/8" (48 mm)	1.945 (49 mm)	
1250	1-1/4" (32 mm)	1-1/2" (38 mm)	1-5/8" (42 mm)	1.755 (45 mm)	
1375	1-3/8" (35 mm)	1-5/8" (42 mm)	1-7/8" (48 mm)	2.005 (50.8 mm)	
1500	1-1/2" (38 mm)	1-1/2" (38 mm)	2" (50.8 mm)	2.130 (54 mm)	
2000	2" (50.8 mm)	2-1/4" (58 mm)	2-1/2" (64 mm)	2.630 (67 mm)	



Part Number

WES696

Do not modify, copy, distribute, or reproduce this drawing without prior written authorization.

© 2025 Wescon Industries Inc.
601 Century Plaza Dr, Houston, TX 77073, US
www.wesconusa.com

Wescon 696 Microstop

Revision 02

All dimensions are in inches

Information in this drawing is provided for reference only

Image 2