

DATASHEET

PART NUMBER

WESSF-32-8-M560

Wescon WESSF Slip/Fixed Renewable Drill Bushing - OD 1/2" - Length 1/2" - Size 5.60 mm

Multi-purpose renewable drill bushings for use with liners.

WEBSITE

<https://www.wesconusa.com/products/WESSF-32-8-M560>



* The image represents the general look of the series. Actual product may vary based on options selected.

Multi-purpose renewable drill bushings for use with liners.

Wescon WESSF Slip/Fixed Renewable Drill Bushings are designed for long-lasting precision in high-volume production environments. These bushings are easily replaceable in a liner, reducing downtime and maintenance costs. Made from high-quality hardened steel, they provide excellent wear resistance and maintain tight tolerances. Ideal for use with Wescon Drill Guides and Drill Bars.

SPECIFICATIONS

Size (ID)	5.60 mm
Body Diameter (OD)	1/2"
Length	1/2"
Country of Origin	USA

ADDITIONAL IMAGES AND DRAWINGS

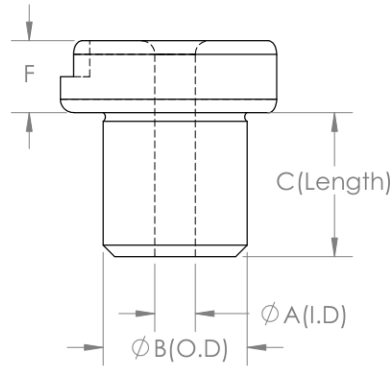
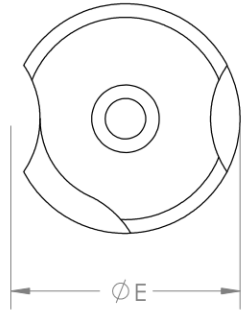

Image 0

WESSF Series SF Drill Bushing



Order as P/N WESSF-OD-LENGTH-SIZE
See wesconusa.com for full list of available sizes and part numbers.



Part Number	Ø A (I.D) +0.0001 to +0.0004	Ø B (O.D) +0.00895	C (Length) ±1/64	Ø E ±1/64	F ±1/64	ANSI
WESSF-20-12	1/16 to #10	5/16"	3/4"	35/64"	1/4"	SF-20-12
WESSF-20-16	1/16 to #10	5/16"	1"	35/64"	1/4"	SF-20-16
WESSF-32-08	5/32 to 11/32	1/2"	1/2"	51/64"	1/4"	SF-32-08
WESSF-32-12	5/32 to 11/32	1/2"	3/4"	51/64"	1/4"	SF-32-12
WESSF-32-16	5/32 to 11/32	1/2"	1"	51/64"	1/4"	SF-32-16
WESSF-48-12	5/16 to 9/16	3/4"	3/4"	1 3/64"	1/4"	SF-48-12
WESSF-48-16	5/16 to 9/16	3/4"	1"	1 3/64"	1/4"	SF-48-16



Notes from our Engineering Team

- Hardened steel construction featuring a Male Knurling for quick and easy installation. Hardness shall be 61-65Rc.
- WESSF is most effective when paired with our WES5703/WES5720 Drill Guides or WES5800 Drill Bars



Part Number	WESSF
Slip Fixed Type Renewable Bushings	

Do not modify, copy, distribute, or reproduce this drawing without prior written authorization.

© 2025 Wescon Industries Inc.
601 Century Plaza Dr. Houston, TX 77073. US
www.wesconusa.com

Revision 00 All dimensions are in Inches Information in this drawing is provided for reference only

Image 1